

ANAFI USA

USER GUIDE v6.7.0.1

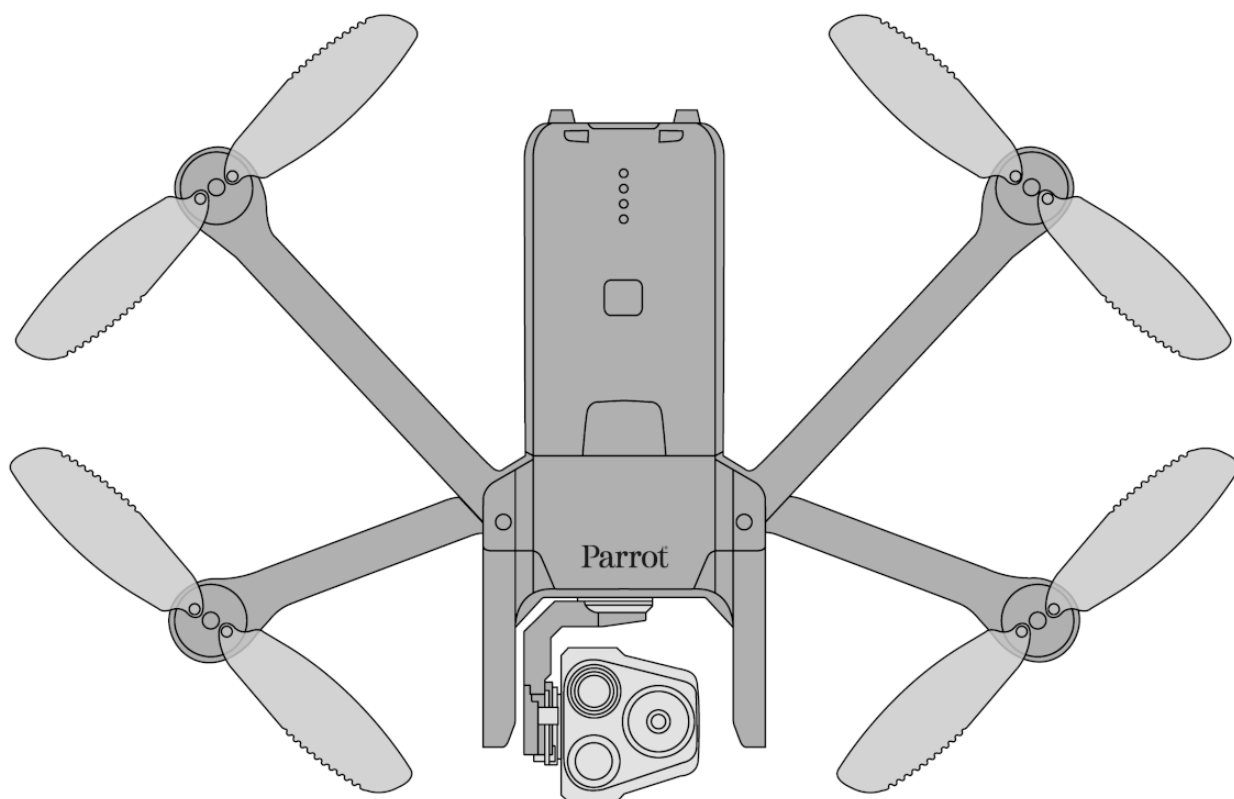

Parrot®

Designed for the U.S. Army
Made for enterprise

WE ARE PARROT. WELCOME TO THE TEAM

With **ANAFI USA**, you have chosen the finest, quietest, and most portable aerial EO/IR system, you can use everywhere on the go, anytime.

We strongly recommend you read the following information and instructions thoroughly before you get **ANAFI USA** in the air, to make the most of your first 32-minute flight.

The indispensable prerequisites, on the next pages, will not occupy more than 5 minutes of your time: **ANAFI USA** requires the FreeFlight 6 app to fly, and to make sure your drone and controller are fully up to date with the latest features.

As you discover the world of possibilities that **ANAFI USA** opens to you, you will fully understand the importance of mission planning in your workflow.

Have a great read, and many productive hours flying **ANAFI USA**.

USING THIS GUIDE

- **Read entirely at least once:** it answers most questions that most users encounter when they discover **ANAFI USA**.
- **Keep it for reference and stay alert for updates:** they will be advertised on all Parrot websites and social media.
- **The Table of contents, on page 7, is active.** Click a title to access the corresponding section.
- **This online user guide has no index:** use [ctrl]-F (Windows) or [command]-F (Mac) to browse all occurrences of any keyword (*flight, preferences, gimbal, Android, iOS, Fliir, Boson[®], photo, EV, ISO*, and so on).

PREREQUISITES

You want ANAFI USA up in the air as soon as possible, so do we. Refer to the enclosed Super Quick Start Guide (SQSG) if you need illustrated guidance to get these quick prerequisites out of the way.

1. **Wake your ANAFI USA's smart battery up.** Charge the battery using one of the enclosed USB-A to USB-C cable and the enclosed charger. The battery's LEDs start flashing; it is awake. Let it charge while you read. **Parrot recommends you always run a full charge of your smart battery before flying ANAFI USA.**
2. **Download FreeFlight 6 on your iOS or Android smartphone: ANAFI USA requires FreeFlight 6 to fly.** The app will enable you to update your **Parrot Skycontroller 3** and **ANAFI USA** when you power them on for the first time.



Android FreeFlight 6 QR code



iOS FreeFlight 6 QR code

When you have downloaded and installed **FreeFlight 6**, unfold the central arm of **Parrot Skycontroller 3** to power it on.

Use your device's USB cable to connect it to **Parrot Skycontroller 3** USB-A port, and install it on the device holder, as shown in the enclosed SQSG.

A prompt appears on your screen, which invites you to allow the communication between your device and the controller.

Tap "Allow" (iOS) or "OK" (Android): **FreeFlight 6** runs. After your device displays the app's splash screen, you get to **FreeFlight 6** homepage.

If the prompt does not appear on your screen when you connect your device to your *Parrot Skycontroller 3*, launch *FreeFlight 6* manually, as any other app.

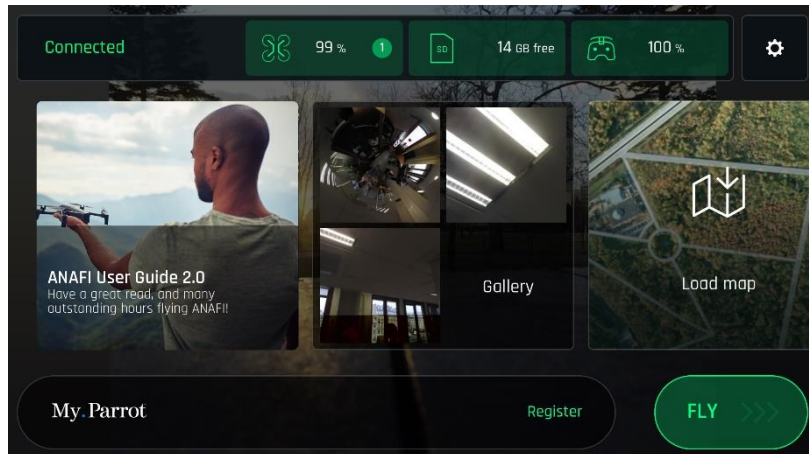

iOS FreeFlight 6 homepage

3. Tap the green "FLY" box on the homepage of FreeFlight 6 to launch the initial updates. FreeFlight 6 automatically updates the Parrot Skycontroller 3 first, and ANAFI USA second.

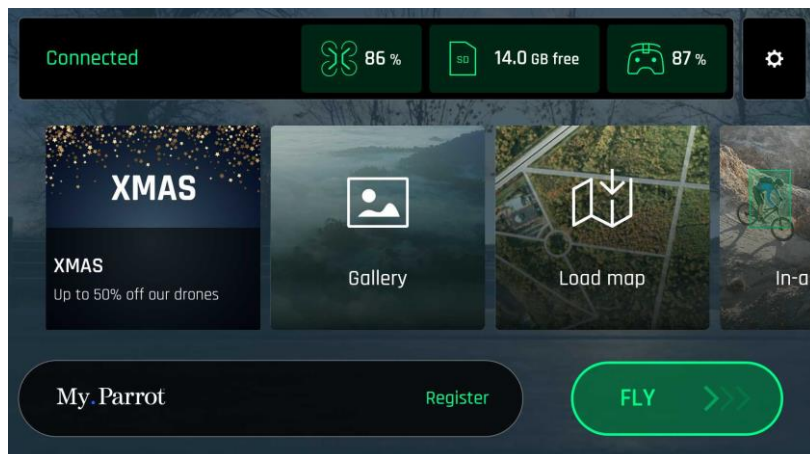

Android FreeFlight 6 homepage

4. Parrot Skycontroller 3 update: tap the green "CONTINUE" box to proceed. FreeFlight 6 displays an animation and a progress circle on a screen labelled "Preparing your controller". When the update is finished, the screen displays "Your controller is ready". Tap "CONTINUE" to access the update of ANAFI USA (screenshots below are Android).

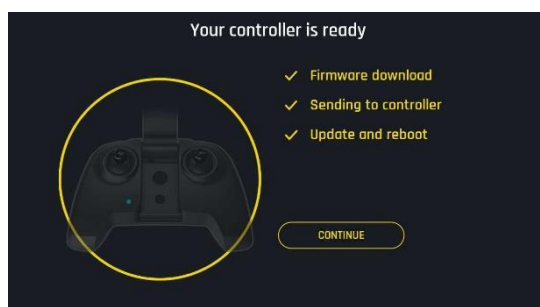

5. **ANAFI USA update: tap the green "CONTINUE" box to proceed.** FreeFlight 6 displays an animation and a progress circle on a screen labelled "Preparing your drone". When the update is finished, the screen displays "Your drone is ready" and a "CONTINUE" box. Tap this "CONTINUE" box to come back to **FreeFlight 6** homepage.

6. **All systems are ready for flight!**

TABLE OF CONTENTS

| | |
|--|----|
| WE ARE PARROT. WELCOME TO THE TEAM..... | 3 |
| USING THIS GUIDE..... | 3 |
| PREREQUISITES..... | 4 |
| TABLE OF CONTENTS..... | 7 |
| FOREWORD..... | 11 |
| About ANAFI USA..... | 11 |
| About Wi-Fi..... | 11 |
| About GPS..... | 11 |
| About 4K video formats..... | 11 |
| About the smart battery..... | 11 |
| About auto-RTH (return home)..... | 12 |
| About devices..... | 12 |
| About My.Parrot accounts..... | 12 |
| DISCLAIMER..... | 13 |
| TECHNICAL SPECIFICATIONS..... | 14 |
| PACKAGE CONTENTS..... | 15 |
| PRESENTATION OF ANAFI USA..... | 16 |
| Ready to store or carry..... | 16 |
| Ready to fly..... | 16 |
| PRESENTATION OF PARROT SKYCONTROLLER 3..... | 17 |
| Ready to store or carry..... | 17 |
| Ready to pilot..... | 17 |
| Camera and gimbal controls..... | 18 |
| LED status indicator color codes..... | 18 |
| Pairing ANAFI USA to a Parrot Skycontroller 3..... | 18 |
| PRE-FLIGHT CHECKLIST..... | 20 |
| Equipment..... | 20 |
| Regulations..... | 20 |
| Flight conditions..... | 20 |
| GETTING STARTED..... | 21 |

| | |
|---|----|
| TAKING OFF | 22 |
| Ground take-off..... | 22 |
| Hand launch | 22 |
| FLYING..... | 23 |
| RETURNING HOME | 24 |
| PRECISE HOME SETTING | 24 |
| SMART RTH..... | 24 |
| COORDINATES AND ADVANCED RTH SETTINGS | 25 |
| Managing coordinates | 25 |
| About advanced RTH settings..... | 27 |
| Pilot RTH | 27 |
| Custom RTH | 28 |
| LANDING | 30 |
| Hand landing..... | 30 |
| REPLACING PROPELLER BLADES | 31 |
| SMART LIPO BATTERY..... | 32 |
| Battery removal | 32 |
| Battery installation | 32 |
| Battery charging | 32 |
| Battery update..... | 33 |
| Battery care and safety..... | 34 |
| MICRO SD CARD AND MEDIA MANAGEMENT | 35 |
| Installing a microSD card | 35 |
| Retrieving photos and videos | 35 |
| Compatible microSD cards..... | 35 |
| Direct media retrieval (drone to computer) | 35 |
| FreeFlight 6 Gallery | 36 |
| MicroSD card formatting..... | 36 |
| MicroSD card encryption..... | 37 |
| INTRODUCING FREEFLIGHT 6..... | 38 |
| Presentation of the iOS HUD (video mode view)..... | 39 |
| Presentation of the Android HUD (photo mode view) | 41 |

| | |
|--|----|
| PREFERENCES..... | 42 |
| Controls | 42 |
| Presets..... | 42 |
| Thermal..... | 43 |
| Interface | 44 |
| Safety..... | 44 |
| Camera | 45 |
| Network | 45 |
| VIDEOS AND PHOTOS..... | 46 |
| Making videos | 46 |
| Taking photos..... | 48 |
| Creating Panoramas..... | 51 |
| GIMBAL TILT AND ZOOM CONTROLS..... | 55 |
| Gimbal tilt control..... | 55 |
| Zoom control..... | 55 |
| Camera Calibration: Correct horizon (exceptional procedure) | 58 |
| Camera Calibration: Gimbal calibration | 60 |
| Camera Calibration: Cameras alignment (exceptional procedure)..... | 60 |
| PRO-IMAGING SETTINGS | 62 |
| Exposure value (EV) | 62 |
| Shutter speed (s) | 62 |
| ISO value (ISO) | 63 |
| White balance (WB)..... | 63 |
| HDR..... | 64 |
| NATURAL Style | 65 |
| P-LOG Style | 65 |
| INTENSE Style | 65 |
| PASTEL Style..... | 66 |
| ADJUSTMENT..... | 66 |
| Lock AE | 67 |
| Lock AE Touch..... | 68 |

| | |
|--|----|
| THERMAL IMAGING..... | 69 |
| About Thermal Imaging | 69 |
| Presentation of the Thermal HUD (post-processing)..... | 69 |
| Relative Thermal mode..... | 70 |
| Spot Thermal mode..... | 71 |
| THERMAL ANALYZER MODE..... | 72 |
| CINESHOTS (VISIBLE SPECTRUM ONLY)..... | 74 |
| 360° | 74 |
| Reveal..... | 74 |
| Spiral | 75 |
| Epic..... | 75 |
| PILOTING MODES..... | 76 |
| Manual flight..... | 76 |
| Cameraman | 76 |
| Follow Me..... | 77 |
| Smartdronies | 79 |
| MAP-BASED FLYING MODES..... | 80 |
| Flight Plan..... | 80 |
| Touch & Fly: Waypoint | 86 |
| Touch & Fly: POI..... | 86 |
| APPENDIX 1: TROUBLESHOOTING GUIDE | 88 |
| APPENDIX 2: OPERATIONAL CHECKLIST..... | 92 |

FOREWORD

About ANAFI USA

ANAFI USA was designed and optimized to fly as is. Parrot therefore strongly discourages the use of any add-on or accessory which could be mounted on, or attached to ANAFI USA (feet extensions, buoys, hulls, etc.). In addition to the overweight they carry for the drone and its motors, they can indeed magnetically disturb ANAFI USA and impair its communications.

About Wi-Fi

Parrot asks you to switch off your device's Wi-Fi connection when flying ANAFI USA with both the Parrot Skycontroller 3 and your phone or tablet: with this configuration, the drone and the controller communicate through ANAFI USA's Wi-Fi network and activating your device's Wi-Fi can only result in interferences.

Therefore, your device's Wi-Fi should **only** be activated – and connected to ANAFI USA's Wi-Fi network – when you want to fly the drone using your device as its sole controller.

About GPS

ANAFI USA does not need a satellite – GPS, Glonass, Galileo – synchronization (or fix) to take off. It can therefore be piloted indoor and through cluttered areas, stabilized by its onboard sensors.

However, automated and assisted flight modes require both ANAFI USA and the FreeFlight 6 device (preferably associated with the Parrot Skycontroller 3) synchronization to geocoordinate satellites – the Parrot Skycontroller 3 alone has no geo-positioning capacity.

For this reason, Parrot recommends ANAFI USA pilots to always set up, start and finish their automated and assisted flights from wide open areas, as a sports field.

About 4K video formats

4K video formats are professional grade media which may not be read natively by slower computers. Shoot in 1080p or use a video converter to turn your ANAFI USA's 4K videos into a more manageable format (like 1080p) if they do not read properly on your equipment. This is especially true for Parrot's 4K Cinema format, which can only be handled by professional editing equipment.

About the smart battery

ANAFI USA's smart battery is preinstalled on your drone. Always install it the same way and never attempt to install it upside down as it could expose your battery and your drone to irrecoverable electrical damage. As you will find out by reading this guide, ANAFI USA's

battery is smart enough to enter a wintering mode when you are not using it for ten days in a row. This also means you need to wake it up and charge it completely before you fly **ANAFI USA** for the first time.

About auto-RTH (return home)

By design, when synchronized to GPS, Glonass and Galileo satellites and when short on power, **ANAFI USA** will always attempt to come back to its most recent take-off point, at a minimal height over this take-off point, which is configurable through **FreeFlight 6** (between 20 meters and 100 meters) and is set by default at 30 meters.

Refer to the *“Coordinates and advanced RTH settings”* and *“PREFERENCES - Safety - Advanced RTH settings”* section of this guide for further information on RTH.

About devices

In this page and the following, the word *“device”* refers to the smartphone or tablet, either iOS or Android-based, on which **FreeFlight 6** is installed.

About My.Parrot accounts

Parrot strongly recommends that you use your My.Parrot account (or create one if **ANAFI USA** is your first Parrot drone) to let Parrot store your **ANAFI USA** flight data. Sharing your data, even anonymously, benefits the community, as it enables us to improve our products.

It also directly benefits all identifiable users in case they need to contact Parrot support teams.

DISCLAIMER

1. **ANAFI USA** IS NOT A TOY and should not be used or handled by a person under the age of 18 years.
2. BEFORE USING **ANAFI USA**:
 - (A) CAREFULLY READ the user manual and all information and documentation available on www.parrot.com, which is susceptible to be updated at any time and without prior notice (hereinafter referred to as "Parrot Documentation"). SPECIAL ATTENTION must be given to the paragraphs marked with the symbol  ;
 - (B) ENSURE YOU ARE AWARE OF THE REGULATIONS APPLICABLE TO THE USE OF DRONES AND THEIR ACCESSORIES (hereinafter referred to as "Applicable Regulations");
 - (C) REMEMBER that **ANAFI USA** may expose others and yourself to EQUIPMENT DAMAGE, PERSONAL INJURY, OR BOTH, which could result in serious harm or death.
3. Be aware that videos and photos that are promoted and advertised by Parrot Drones SAS and its affiliates have been made by and with experienced professionals and drone pilots. IN CASE OF DOUBT RELATING TO THE USE OF YOUR **ANAFI USA** DRONE AND ITS ACCESSORIES, ALWAYS REFER TO THE MOST RECENT VERSION OF THE PARROT DOCUMENTATION.
4. TO THE EXTENT PERMITTED BY APPLICABLE LAW, PARROT DRONES SAS, ITS SUBSIDIARIES, AND THEIR RESPECTIVE DISTRIBUTORS AND RETAILERS SHALL NOT BE LIABLE FOR ANY DAMAGES ARISING FROM, OR IN CONNECTION WITH THE NON-COMPLIANCE OF PARROT WITH THE DOCUMENTATION OR THE APPLICABLE REGULATIONS BY YOURSELF OR ANY PERSON USING YOUR **ANAFI USA**.

TECHNICAL SPECIFICATIONS

DRONE

- Weight: 500 g / 1.1 lb.
- Maximum transmission range: 4 km (2.48 mi) with the enclosed Parrot Skycontroller 3
- Maximum flight time: 32 minutes
- Maximum horizontal speed: 14.7 m/s (52.92 km/h or 32.88 mph)
- Maximum vertical speed: 6 m/s (21.60 km/h or 13.42 mph)
- Maximum wind resistance: 14.7 m/s (52.92 km/h or 32.88 mph)
- Service ceiling: 6.000 m above MSL (Mean Sea Level)
- Optional altitude fencing & geofencing
- Operating temperature: -32F (-35 °C) to 110F (43 °C)
- No take-off temperature limitation
- No NFZ (no-fly zone) limitation
- Takes off from / lands in the hand of the operator
- Manage your data privately between drone and device OR share anonymous data on secured European servers

DIMENSIONS:

- Size folded: 252 x 104 x 82 mm (9.92 x 4.09 x 3.23")
- Size unfolded: 282 x 373 x 84 mm (11.10 x 14.69 x 3.30")

SENSORS:

- Satellite navigation: GPS, GLONASS & GALILEO
- Barometer and magnetometer
- Vertical camera and ultra-sonar
- 2 x 6-axis IMU
- 2 x 3-axis accelerometers
- 2 x 3-axis gyroscopes

EO IMAGE CHAIN

- 2 Sensors: 1/2.4"
- Digital zoom: 32x
- Electronic shutter speed: 1 s to 1/10000 s
- ISO range: 100-3200
- Video resolution: 4k/FHD/HD
- Video format: MP4 (H264)
- Photo resolution: Wide: 21 MP (84° FOV); Rectilinear: up to 16 MP (up to 75.5° FOV)
- Photo formats: JPEG, DNG (Digital NeGative RAW)

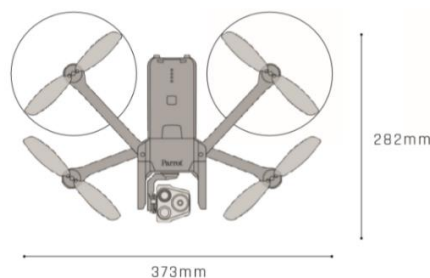

IR IMAGE CHAIN

Sensor: FLIR BOSON

- 320x256 resolution
- -40 °C to +150 °C temperature range
- Thermal sensitivity: <60 mK
- Photo format: JPEG
- Video format: MP4 (H264)
- Video recording resolution: 1280x720, 9 fps

IMAGE STABILIZATION

- 3-camera IR/EO stabilized gimbal:
 - Hybrid: 3-axis
 - Mechanical: 2-axis roll / pitch
 - Electronics (EIS): 3-axis yaw / roll / pitch
- Controllable gimbal tilt range: -90° to +90°

FAST-CHARGING SMART BATTERY

- Type: High density LiPo (3 x 4.4 V cells)
- Capacity: 3400 mAh
- Battery life: 32 minutes
- Charging port: USB-C
- Charges in 2h with an USB-PD (Power Delivery) charger - not included in the pack
- Charges in 3h20 with the fast-charging port of the provided charger
- Weight: 195 g / 0.43 lb.
- Voltage: 11.55 V
- Max charging power: 30 W

PARROT SKYCONTROLLER 3

- Folded size: 94x152x72 mm
- Unfolded size: 153x152x116 mm
- Weight: 283 g / 0.62 lb
- Transmission system: Wi-Fi 802.11a/b/g/n
- Operating frequencies: 2.4 - 5.8 GHz
- Max. transmission distance: 4 km / 2.48 mi
- Resolution of live video feed: HD 720p
- Battery capacity: 2500 mAh 3.6 V
- Battery life: 2h30 (Android) / 5h30 (iOS)
- Compatible mobile devices: screen size up to 6.5"
- USB ports: USB-C (charge), USB-A (connection)

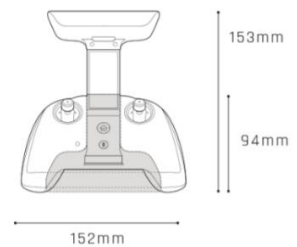
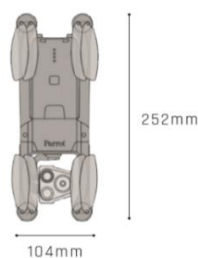

PACKAGE CONTENTS

Your **ANAFI USA** package contains:

- 1 **ANAFI USA** drone
- 3 smart batteries (2 + 1 preinstalled on **ANAFI USA**)
- 1 **Parrot Skycontroller 3**
- 1 tablet holder
- 1 multi-port fast USB charger
- 1 additional set of propeller blades
- 4 USB-A/USB-C cables
- 1 hard case



Illustration picture: device not included in the pack

PRESENTATION OF ANAFI USA

Ready to store or carry



Ready to fly

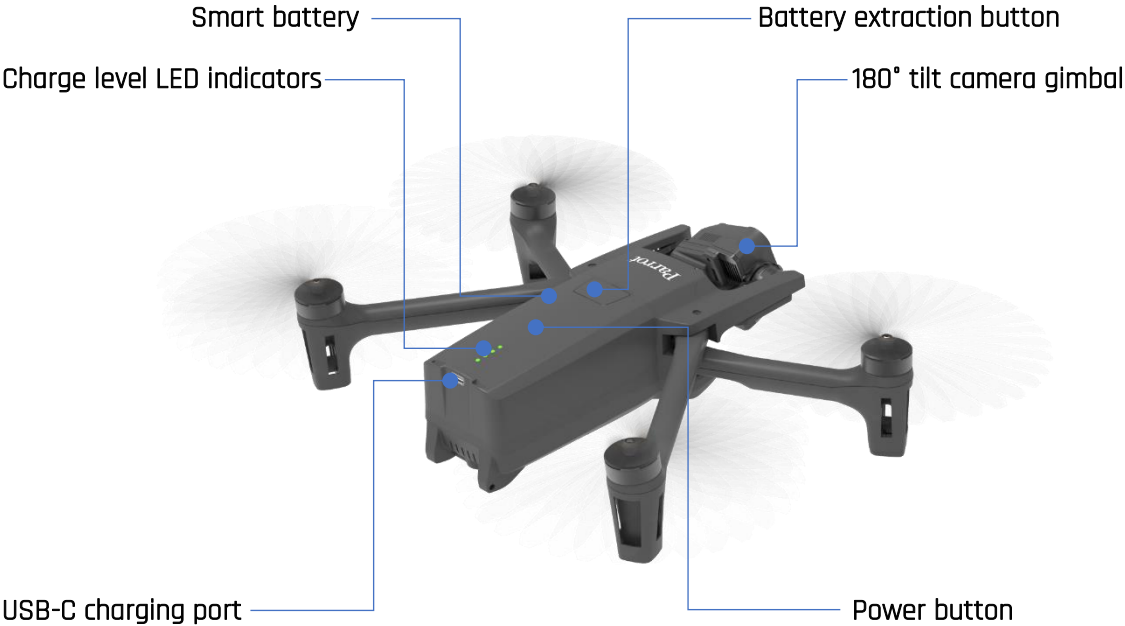

PRESENTATION OF PARROT SKYCONTROLLER 3

Ready to store or carry

Left control stick

Right control stick



Power-on foldable arm and device holder

Ready to pilot

LED status indicator

Wi-Fi antenna



RTH (return home) button

Take-off/landing button

Camera and gimbal controls

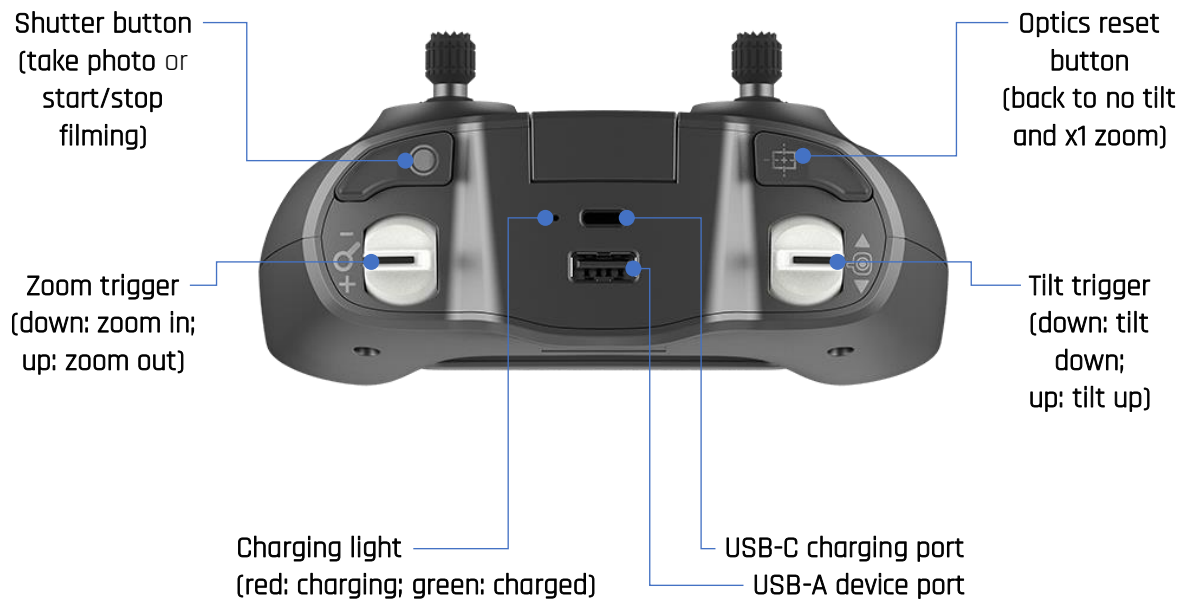

LED status indicator color codes

When the **Parrot Skycontroller 3** is powered on, its LED status indicator gives you an instant visual indication:

- | | |
|---|---|
| - flashing green: | Skycontroller 3 update in progress; |
| - alternating light blue and dark blue: | connecting to ANAFI USA ; |
| - flashing light blue: | no drone configured or wrong WPA key; |
| - steady dark blue: | connected to ANAFI USA ; |
| - alternating purple and dark blue: | autonomous flight in progress; |
| - alternating red and any other color: | low battery alert (ANAFI USA , Skycontroller 3 , or both) or RTH alert. |

Pairing ANAFI USA to a Parrot Skycontroller 3

This procedure is useful to pair a drone and a controller which have never been paired, and to restore the lost pairing between a drone and a controller.

1. Check a compatible microSD card is inserted into **ANAFI USA**.
2. Power **ANAFI USA** on.
3. Open the **Parrot Skycontroller 3** to power it on.
4. Plug the drone and the controller together with an USB-A (controller) to USB-C (drone) cable.
5. The LED of the **Parrot Skycontroller 3** flashes briefly in green: it is acknowledging **ANAFI USA**.

6. Wait for synchronization between **Parrot Skycontroller 3** and **ANAFI USA** (steady dark blue LED on the controller); check that the left trigger of the **Parrot Skycontroller 3** activates the drone's gimbal to ensure the synch is complete.
7. Unplug the controller from the drone.

PRE-FLIGHT CHECKLIST

Equipment

- ⚠ Make sure you have downloaded the latest version of FreeFlight 6 and that both your Parrot Skycontroller 3 and your ANAFI USA have been updated with the latest versions of firmware.
- ⚠ For the best ANAFI USA experience, make sure you have the right USB-A cable to connect your Parrot Skycontroller 3 and your device.
- ⚠ Make sure ANAFI USA is fitted with a microSD card with enough free memory space.
- ⚠ Make sure all four foldable arms of ANAFI USA are unfolded.
- ⚠ Make sure its propellers are clean, intact and unobstructed.
- ⚠ Make sure both ANAFI USA's and Parrot Skycontroller 3's batteries are fully charged.
- ⚠ Make sure ANAFI USA's battery is securely installed on the drone's body.
- ⚠ Make sure the gimbal cap has been removed from ANAFI USA.
- ⚠ Make sure ANAFI USA's lenses are clean – if you need to clean them, hold the gimbal between two fingers so that you do not pressure its mechanism when you clean the lenses, and gently wipe the lenses with a microfiber cloth.

Regulations

- ⚠ Make sure the use of ANAFI USA is allowed where you are intending to fly.
- ⚠ Check for potential restrictions regarding the use of Wi-Fi frequencies in the area where you are intending to fly.

Flight conditions

- ⚠ Check that your flying zone is safe and clear.
- ⚠ Do not fly ANAFI USA over urban areas or over restricted airspaces such as airports, train stations, power plants, national reserves, and so on.
- ⚠ Check the weather: do not fly ANAFI USA in the fog or in a wind exceeding 15 meters per second or 50 km/h.
- ⚠ Due to the operating mode of its vertical camera and ultrasound sensor, Parrot recommends you do not fly ANAFI USA over water and other reflective surfaces (mirrors, glass, and so on).

ANAFI USA has been designed to assist first responders at a second's notice, whatever the time, location and weather conditions. It has no inbuilt no-fly zone limitation, it can fly in the rain and can be very useful at night. Always deploy ANAFI USA responsibly.

GETTING STARTED

1. Charge the battery using the enclosed USB-A to USB-C cable and a USB-A power adapter (not included in the box, except for **ANAFI USA Work**). Charging times depend on the supply capacity of the adapter. Refer to the *"Battery charging"* section of this guide for additional information. **Parrot recommends you always run a full charge of your smart battery before flying ANAFI USA.**
2. If you want to use the controller and enjoy the full **ANAFI USA** experience, charge **Parrot Skycontroller 3**.
3. Check that your flying zone is safe and clear.
4. To start the drone, place it on a flat horizontal surface and press the power button.
5. **a) If you use Parrot Skycontroller 3**, unfold the central part of the controller to power it on, wait for the steady dark blue light, then plug your device to the controller using a USB cable. **Parrot recommends you always fly ANAFI USA with Parrot Skycontroller 3 and a device, for the best flight experience.**
b) If you do not wish to use the controller, connect your device to the Wi-Fi network of **ANAFI USA**, using the Wi-Fi settings card located inside the drone's carrying case - SSID format: ANAFI USA-xxxxx.
6. **FreeFlight 6** runs automatically on your device and connects to **ANAFI USA** and to **Parrot Skycontroller 3**.
7. Check for controller and drone software updates.
8. Calibrate your **ANAFI USA**, your **Parrot Skycontroller 3**, or both, if required, following the instructions on the screen of your device.
9. Check that your flying zone is still safe and clear, and that no one (people, animal) has approached or is approaching **ANAFI USA**.
10. Stay at least 2 m (6 ft) clear from the drone, press the  button and enjoy the flight!

TAKING OFF

Ground take-off

Position **ANAFI USA** on a flat, even, and clear surface.

Power it on, move at least 2 m (6 ft) away from **ANAFI USA** and check that the surroundings of the drone are absolutely clear.

Press the  button on your **Parrot Skycontroller 3**, or tap the green "TAKE-OFF" box, on the screen of your device.

ANAFI USA takes off and stabilizes at 1 m (3 ft) from the ground, waiting for commands from the pilot.

Hand launch

- ⚠ Be especially careful when you hand launch **ANAFI USA**. This procedure is safe provided you are not distracted or startled by an outside event with a live drone in your hand: concentrate on what you are doing, but always stay aware of your surroundings.

Upon first opening of **FreeFlight 6**, a hand launch tutorial reminds you the following procedure. You can activate hand launch from this tutorial page.

You can also activate the hand launch option from the "Interface" menu of **FreeFlight 6 "PREFERENCES"** (refer to the "PREFERENCES - Interface" section of this guide for further information).

Power **ANAFI USA** on and position the drone on your flat, open hand. On the screen of your device, the green "TAKE-OFF" box is replaced by a blue "HAND LAUNCH" box.

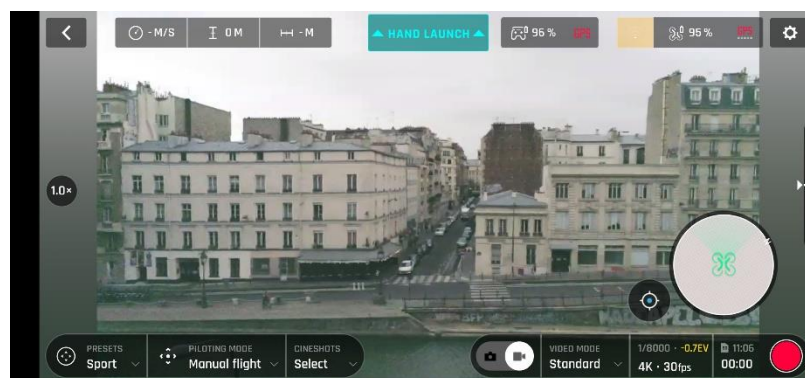





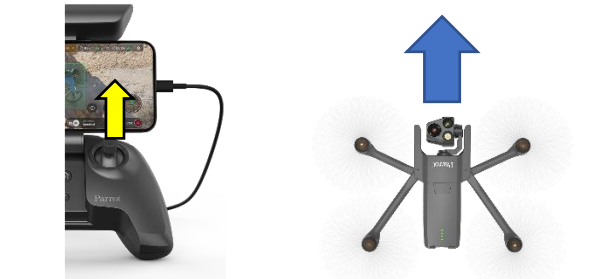

ANAFI USA: Android "Hand Launch" Screen

Press the  button on your **Parrot Skycontroller 3**, or tap the blue "HAND LAUNCH" box on the screen of your device. The drone's blades start rotating slowly and the screen of your device displays a hand-launch animation.

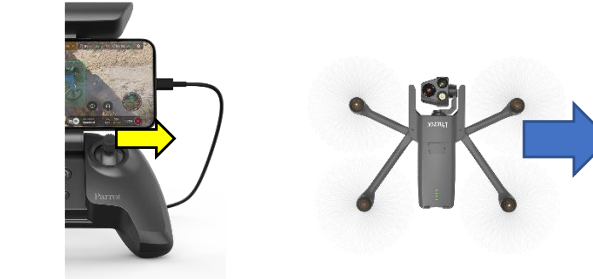

Briefly and briskly lift ANAFI USA up and forward with your open hand. **ANAFI USA** is airborne. It stabilizes, waiting for commands from the pilot.

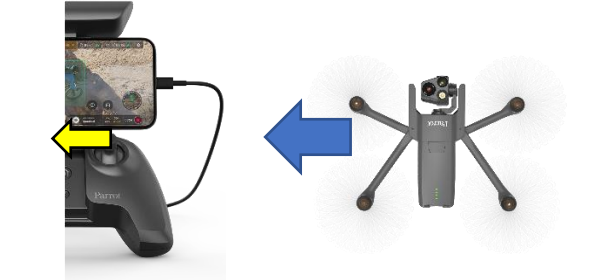
FLYING

| Left control stick (default mode) | Right control stick (default mode) |
|---|---|
|  <p>Rise</p> |  <p>Forward</p> |
|  <p>Descend</p> |  <p>Reverse</p> |
|  <p>Turn right</p> |  <p>Move to the right</p> |
|  <p>Turn left</p> |  <p>Move to the left</p> |

- Note that you can modify **ANAFI USA's** controls through the PREFERENCES menu of **FreeFlight 6**. Refer to the *"PREFERENCES / Controls"* section of this guide for additional information.
- **ANAFI USA's** controls can also be set in Arcade mode. Refer to **ANAFI's** general documentation for additional information.

RETURNING HOME

To bring **ANAFI USA** back to its take-off position, press the  button on your **Parrot Skycontroller 3**, or tap the  icon on the screen of your device.

ANAFI USA rises to 30 meters over its take-off point - or to the altitude you have set, through **FreeFlight 6**, between 20 and 100 meters - and flies back over its take-off position.

Refer to the *"PREFERENCES - Safety"* section of this guide for further instructions on RTH configuration.

PRECISE HOME SETTING

When flight conditions are optimal at take-off, **ANAFI USA** can set a "precise home" for itself, through its vertical camera. In that case, a pop-up on the screen of **FreeFlight 6** confirms a precise home has been set, and the home icon of the minimap turns green.

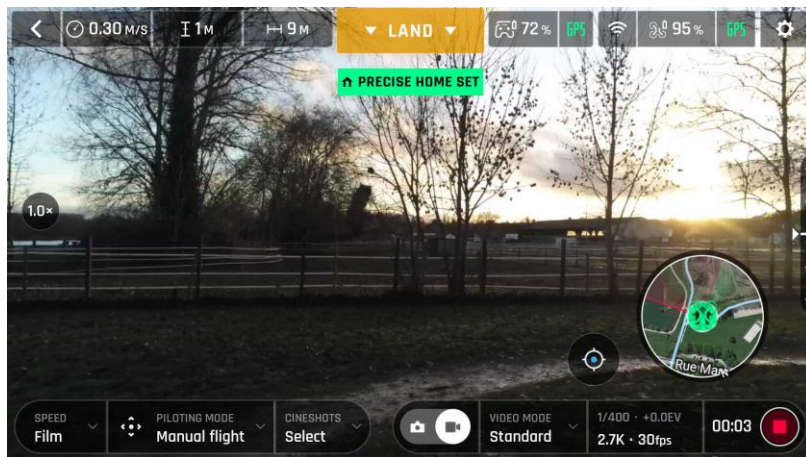

Android "Precise Home Set" pop-up

SMART RTH

ANAFI USA features a Smart RTH capability: considering its altitude and its distance from its take-off point, the drone computes in real time the power it needs to return home - or to the pilot, or to a custom location (refer to the *"PREFERENCES / Safety / Advanced RTH settings"* of this guide for additional details on this feature). When short on battery power, **FreeFlight 6** alerts you that it will enter automatic RTH mode.

If you feel confident you can bring **ANAFI USA** back to its take-off point or if you wish to land it at a different location, you can cancel the auto-RTH directly from the alert pop-up.

COORDINATES AND ADVANCED RTH SETTINGS

ANAFI USA features a fly-by-coordinates function which allows you to instantly display, reuse and share any coordinates in the surroundings of your drone – or indeed the GPS position of your drone itself. This is especially useful to precisely locate any point of interest or person **ANAFI USA** has detected.

This section explains how to access coordinates on the **FreeFlight 6** app map, in flight or to prepare a flight – same simple procedure.

It then presents the advanced RTH function of the drone, and notably the custom RTH option, which relies on managing coordinates.

Managing coordinates

By default, coordinates are displayed on the **FreeFlight 6** app map. They can be set as latitude and longitude (LATLNG: default value), MGRS (Military Grid Reference System: NATO's geocoordinate standard), UTM (Universal Transverse Mercator), or DMS (degree, minute, second – of arc). Refer to the *“PREFERENCES – Interface – Coordinates system setting”* section of this guide for information on selecting a coordinates system.

In the following example, coordinates system is set on DMS. The drone is offline and the device is connected to local Wi-Fi.

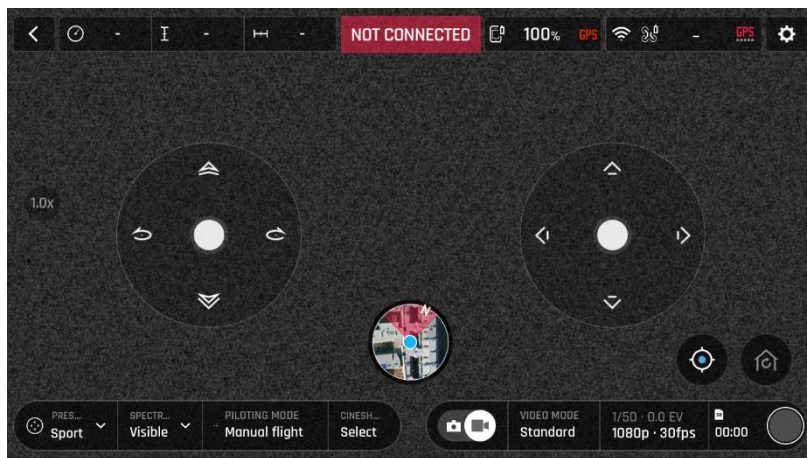

Offline FreeFlight 6 interface: tap minimap to open full screen (iOS)

Tap “FLY” from the **FreeFlight 6** homepage.

Tap the minimap on the bottom center of the offline interface to access the full screen map.

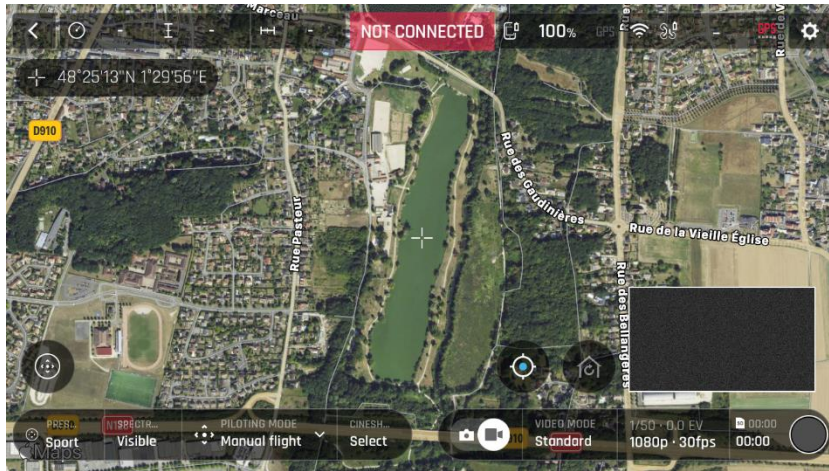

Reticle (crosshair) at the center of the screen, coordinates top left (iOS)

By default, “Reticle” (crosshair at the center of the screen) coordinates are displayed on the top left of the screen.

Move the map around and zoom in to pinpoint any spot, then tap the coordinates box to activate coordinates options.

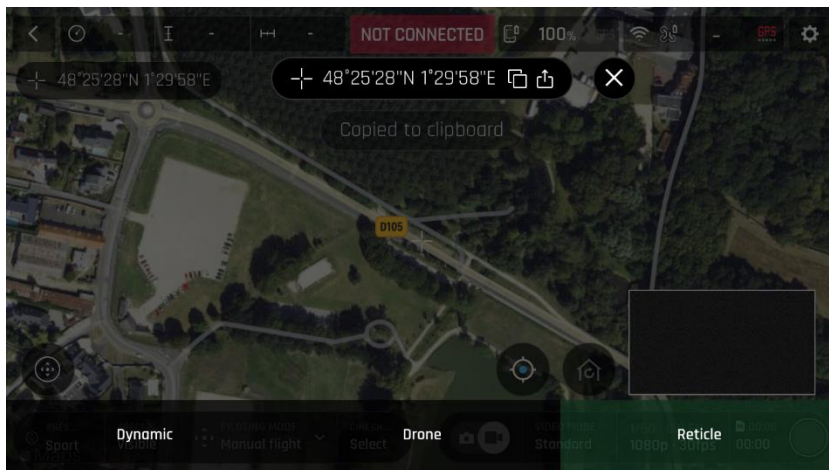

Coordinates options, copy activated (iOS)

Tap  to copy coordinates to clipboard – and reuse as custom RTH point, for instance. Note the faint “Copied to clipboard” notification on the latest screen capture – notification position and format differ, from a device operating system to the other.

Note the options at the bottom of the screen (tap to select):

- Reticle (default value) displays center of the map coordinates
- Drone displays drone coordinates (when online) or its last known position (when offline) on some devices
- Dynamic displays drone, POI or WP coordinates (autonomous or assisted flights only*)

**Refer to the “Map based flying modes” section of this guide for further information on autonomous and assisted flights.*

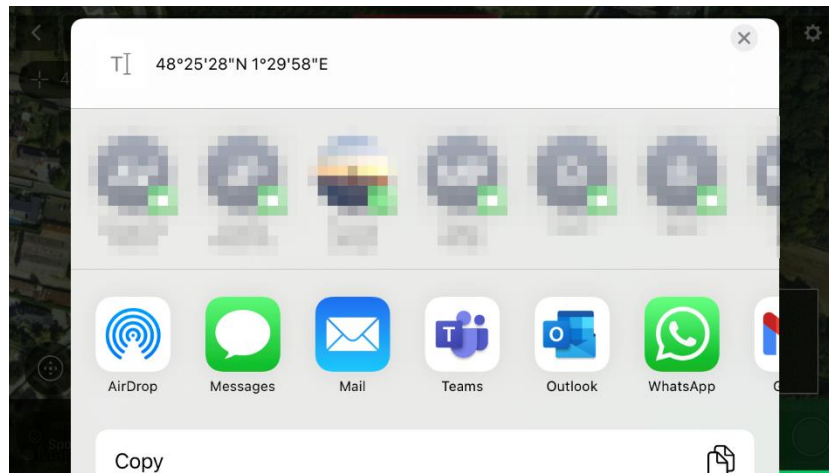

Sharing options (iOS)

Tap  from coordinates options to open your device's sharing options, like on the screenshot.

Tap X to exit coordinate options back to the full screen map.

About advanced RTH settings

Activate advanced RTH settings through the Safety Preferences of **FreeFlight 6** (refer to the *"PREFERENCES – Safety"* section of this guide for further information).

There are two advanced RTH options: Pilot & Custom.

-  *By activating advanced RTH features, if you select return to Pilot or Custom position, the drone might not be able to reach its destination in case of low battery. Parrot will not be held responsible in case the drone lands in a different location.*

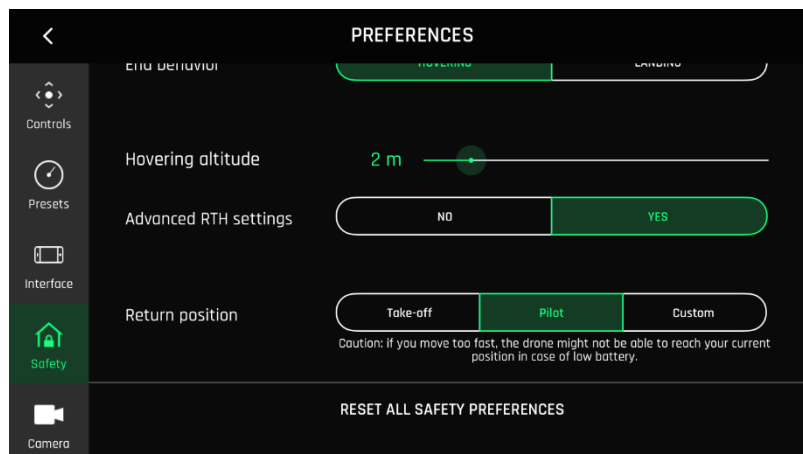

Advanced RTH settings activated (iOS)

Pilot RTH

When the "Pilot" advanced RTH option is selected, **ANAFI USA** comes back to the GPS position of the device used to control the drone (whether linked to a **Parrot Skycontroller 3** or not) at the exact moment an RTH button is activated – or to the last known coordinates of the device, in case it has lost GPS synch.

For this reason, we recommend ANAFI USA pilots not to move, after they have activated an RTH button, when in "Pilot" advanced RTH mode.

- ⚠ Note that when the Smart auto-RTH function is activated in "Pilot" advanced RTH mode, ANAFI USA comes back to the GPS position of the device, at the moment of the activation of the auto-RTH function - or to the last know coordinates of the device, in case it has lost GPS synch.

Custom RTH

By default, when you have set up ANAFI USA for a flight, provided it has a GPS synch, when you activate the "Custom" advanced RTH option, the current position of the drone appears in the "Custom point" field.

There are two ways to change this custom point.

- Paste the coordinates you have copied from the map of **FreeFlight 6** - refer to the earlier section of this guide.
- If you have set up your drone for a flight, apply the following simple procedure to move the "Home" icon directly on the map of **FreeFlight 6**.

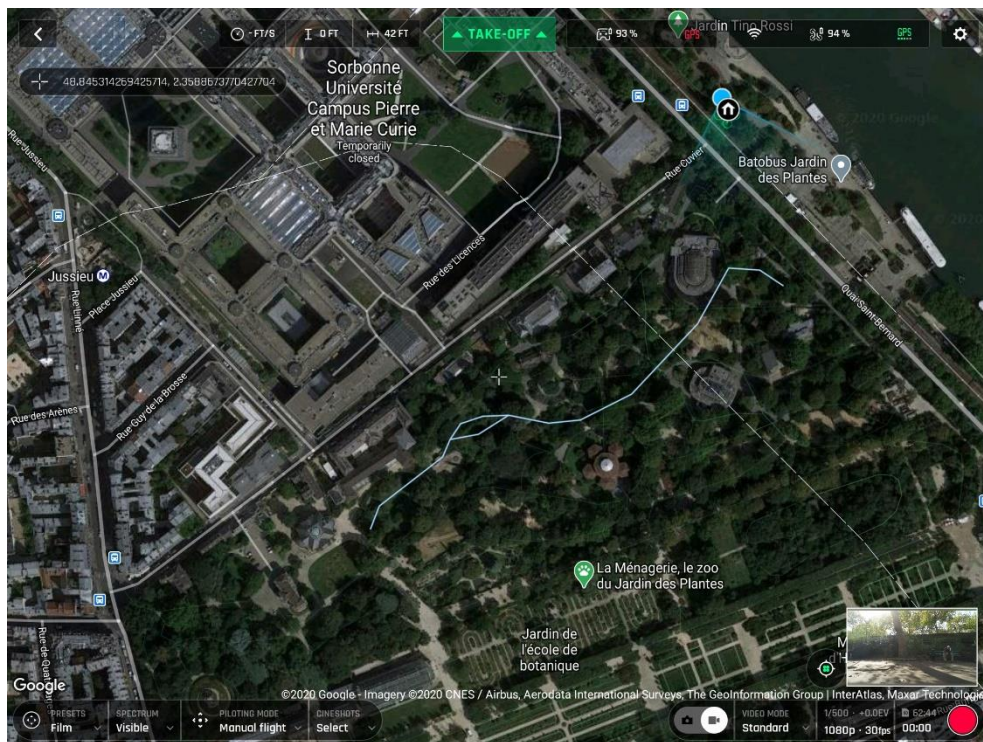

Initial home, at flight setup (Android tablet)

The "Home" icon appears close to the drone icon - or exactly over the drone icon if the 1st GPS fix at power up was excellent, like in our example. The blue dot materializes the position of the controller - typically that of the pilot.

Press the "Home" icon to activate it, then drag and drop it to your desired RTH point.

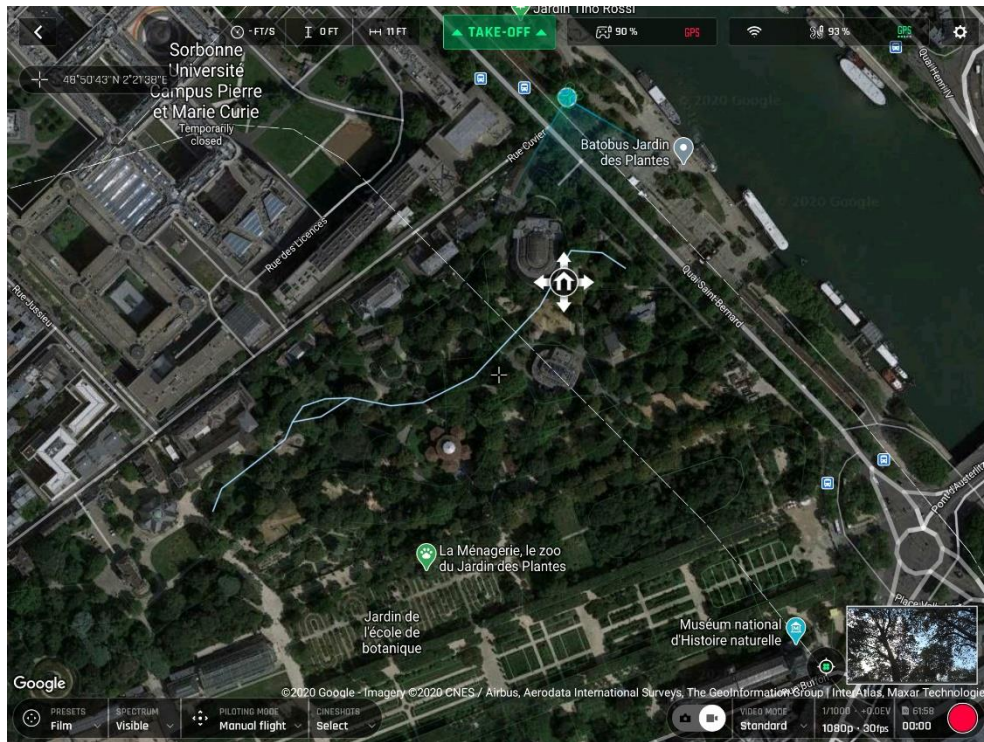

Home icon activated, ready to be dragged and dropped (Android tablet)

In our example, we have set up for a flight at a corner of a park, and planned an RTH over an open area, close to the center of the same park.

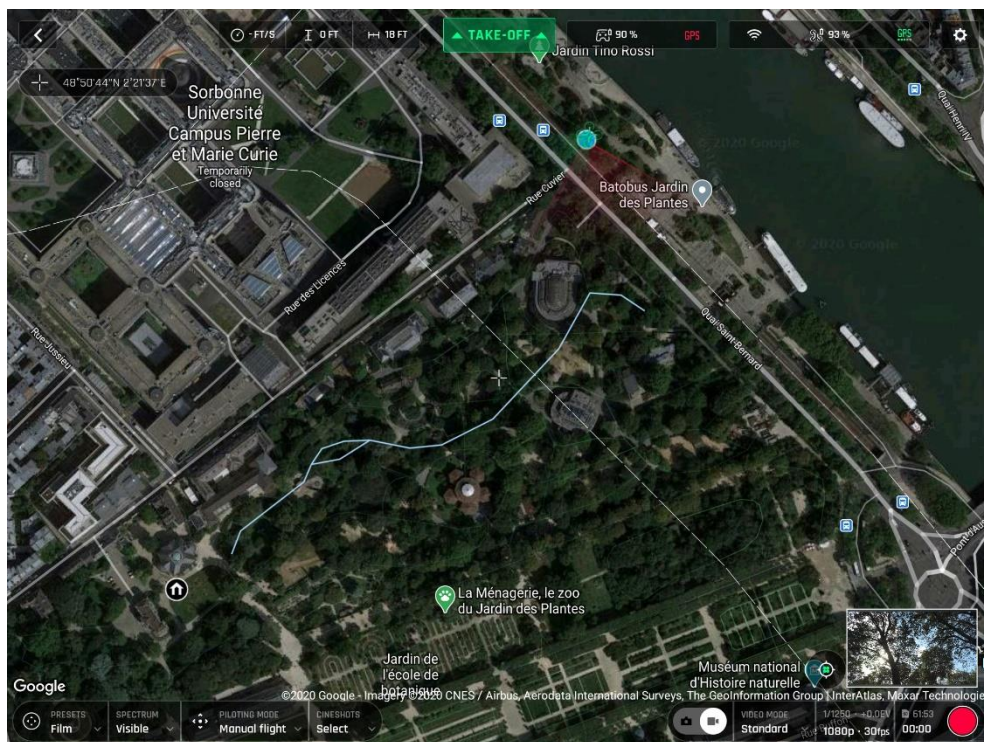

Custom RTH point set (Android tablet)

Access Safety Preferences again and note the Custom point coordinates have been updated. You are set!

LANDING

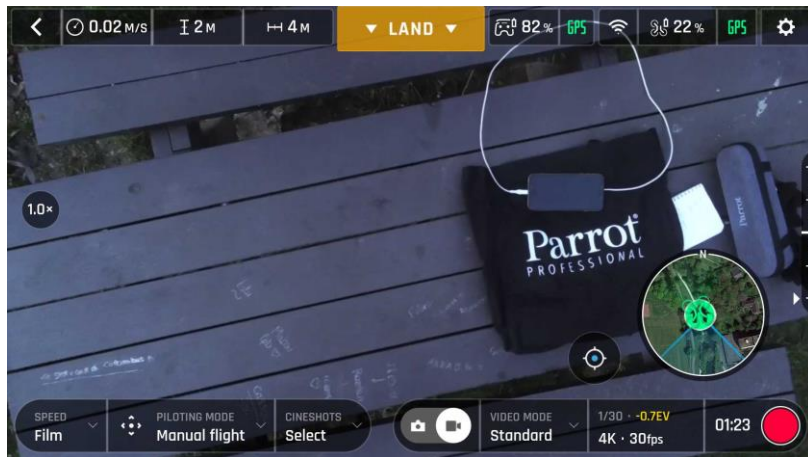

Setting up for landing, Android

Fly ANAFI USA directly over a flat, even, and clear surface, then press the  button, or tap the orange "LAND" box on the screen of your device.

ANAFI USA lands.

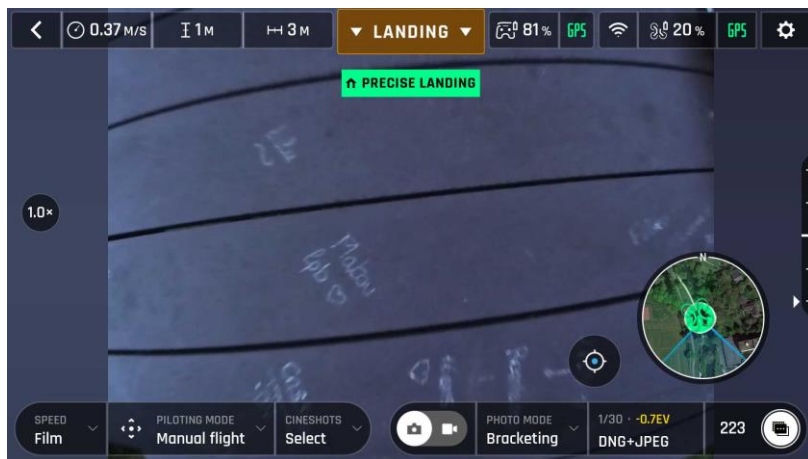

Precise Landing, Android

Hand landing

-  Be especially careful when you hand land ANAFI USA. This procedure is safe provided you are not distracted or startled by an outside event with a live drone approaching your hand: concentrate on what you are doing, but always stay aware of your surroundings.

Fly ANAFI USA at least 50 cm directly over your open hand then press the  button, or tap the orange "LAND" box on the screen of your device.

ANAFI USA lands on your hand.

REPLACING PROPELLER BLADES

Propeller blades are instrumental for flight integrity and delicate pieces of equipment. Even minor contacts with external elements (wall, tree branch, etc.) can invisibly damage their structure.

Therefore, Parrot recommends you immediately replace propeller blades which have sustained such a contact.

ANAFI USA propeller blades have been designed for instant, no tool replacement. To replace a propeller blade, follow this simple procedure.

1. Unfold the arm that supports the blades which need to be replaced.
2. Hold the motor (round rotating part) of the propeller between your left thumb and index.
3. Unfold the blades and pinch the part which screws on the motor, between the blades, with your right thumb and index.

A. blades: unscrew damaged A blades (left front & right back) counterclockwise and screw new ones clockwise.



B. blades: unscrew damaged B blades (left back & right front) clockwise and screw new ones counterclockwise.



Double check your blades respect the following diagram before setting up **ANAFI USA** for its next flight.

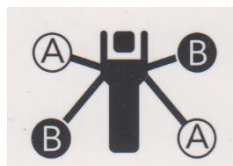

SMART LIPO BATTERY

ANAFI USA's smart LiPo battery is preinstalled on the drone and should always be reinstalled in the same way, with the LEDs and power button facing up, to avoid irrecoverable electric damage to the battery, to the drone, or to both.

The smart battery can be charged whether it is installed on ANAFI USA, or not. When handling ANAFI USA, you should never apply pressure and generally avoid touching the drone's gimbal – its most sensitive part. The following directions will help you handle your drone and battery safely.

Battery removal

To remove the smart battery from the drone, unfold the back arms of ANAFI USA. Set the drone on a flat and even surface (such as a table), and press the push-button which connects the battery to the body of the drone with your thumb. Gently slide your thumb and the battery toward the back of ANAFI USA. When the hook of the push-button is disengaged from the body of the drone, lift the battery away from ANAFI USA.

Battery installation

To install the smart battery back on the drone, unfold the back arms of ANAFI USA. Set the drone on a flat and even surface (such as a table), and position the battery's three hooks into the drone's corresponding slots. Place your middle finger on the Parrot logo of ANAFI USA and your thumb on the back of the smart battery. Squeeze your fingers together until you feel and hear the battery clicking into the body of the drone. You are set!

Battery charging

To charge ANAFI USA's smart LiPo battery, use the enclosed USB-A to USB-C cable to plug the battery to a power source. This convenient cable enables you to charge your battery from:

- the enclosed charger;
- a tabletop or laptop computer's USB-A port;
- a power bank's USB-A port.

Indicative **full charging times** depending on power sources are as follows (at 20°C):

- enclosed charger: between 200 and 240 minutes;
- a computer's or power bank's USB-A port: between 300 and 350 minutes.

ANAFI USA's smart battery can also be recharged through a Power Delivery adapter or charger (USB-PD standard), using a USB-C to USB-C cable (not included in the box). In that configuration, full charging time of the battery can be reduced to 115 minutes.

- ⚠ **About USB-PD power banks:** Parrot does not recommend ANAFI USA users to invest in a USB-PD power bank, as not all of them support USB-C to USB-C charging of ANAFI USA's battery. Indeed, due to the nature of the USB-C technology, some USB-PD power banks recharge on ANAFI USA's smart battery, rather than the other way around.

When ANAFI USA's smart LiPo battery is plugged to a power source and charging, its 4 LEDs indicate in real time its level of charge:

- LED 1 flashing: battery is between 0 and 25% charged;
- LED 1 steady & LED 2 flashing: battery is between 25 and 50% charged;
- LEDs 1 and 2 steady & LED 3 flashing: battery is between 50 and 75% charged;
- LEDs 1, 2 and 3 steady & LED 4 flashing: battery is between 75 and 100% charged;
- battery is plugged and all LEDs are off: battery is full.

Similarly, when **your battery is not installed on ANAFI USA**, you can check its charge level at any time by pressing its power button:

- 1 steady LED lights up: battery is between 0 and 25% charged;
- 2 steady LEDs light up: battery is between 25 and 50% charged;
- 3 steady LEDs light up: battery is between 50 and 75% charged;
- 4 steady LEDs light up: battery is between 75 and 100% charged.

Finally, the same logic applies when **the smart LiPo battery is installed on the drone and when ANAFI USA is powered on**. The number of steady LEDs enables you to estimate your remaining flying time:

- 1 steady LED is lit up: less than 8 minutes flying time remaining;
- 2 steady LEDs are lit up: between 8 and 16 minutes flying time remaining;
- 3 steady LEDs are lit up: between 16 and 24 minutes flying time remaining;
- 4 steady LEDs are lit up: between 24 and 32 minutes flying time remaining.

Battery update

ANAFI USA smart batteries can be updated, like the drone itself, its controller and its controlling software **FreeFlight 6**. When a battery update is available with a **FreeFlight 6** release, a message appears in the app.

Follow the simple in-app instructions to update your battery.

- ⚠ **Remember to keep your battery plugged to a power supply throughout the procedure and repeat it with all your batteries.**

Battery care and safety

As you can see, ANAFI USA's smart LiPo battery is as high-tech as any other element of your drone. It even features a wintering mode, designed to increase its durability and facilitate its care. Ideally, when not in use for a prolonged period, batteries should be stored half-charged. When not in use for 10 days, ANAFI USA's smart battery discharges itself, if required, to 65% charge, over a 48h period. In other words, after a maximum of 12 days without use, this smart battery enters hibernation with a charge level which never exceeds 65%. If you leave your ANAFI USA battery for 12 days, you will find out its power button does not activate the charge level LED indicators. **The battery needs to be charged to exit the wintering mode and start operating as described in the earlier paragraphs: this behavior preserves the battery over time. Parrot recommends you always run a full charge of your smart battery before flying ANAFI USA.**

Like all other LiPo batteries, ANAFI USA's smart battery must be handled, transported and stored with care:

- never leave a battery unattended while charging;
- never expose a battery to extreme temperatures, neither hot, nor cold;
- never charge a battery which is still warm from use (wait for at least 20 minutes);
- never use or recharge a damaged or swollen battery;
- always store your battery in a dry, ventilated place, at a temperature close to 20°C;
- always carry your battery in a fire-retardant bag or case (unless it is installed on ANAFI USA: it can then be transported with the drone, inside its carrying case).

Finally, note that ANAFI USA's smart battery will only allow charge in ambient temperatures between +10°C and +45°C, and that using ANAFI USA in temperatures approaching -10°C will reduce its flying time. To minimize this slight drop in the smart battery's capacity, keep your battery as warm as possible before starting a flight in a cold environment.

- ⚠ If the behavior of your battery is not consistent with the elements contained in this section, and if you cannot get it to power your ANAFI USA, you must hard reset your battery: plug it to a power source with the enclosed cable, then keep the battery's power button pressed for 15 seconds (regardless of the behavior of the LEDs), and release the button.

The battery's LEDs flash quickly, one after the other, alternating green and red: the hard reset is successful!

MICRO SD CARD AND MEDIA MANAGEMENT

This section explains how to install a microSD card inside ANAFI USA and how to retrieve your media from the microSD card.

Installing a microSD card

To install a microSD card into its slot, the battery must be removed from the drone. Refer to the *"Battery removal"* section of this guide for details.

When you remove the battery from the body of the drone, you uncover the microSD slot, which is protected by a small metal lock.

Slide the metal lock with a finger toward the back of ANAFI USA to open it – you will feel a slight click. Lift the front part of the lock to open the slot. Position the microSD card into its keyed slot: make sure the metal contacts of the card are facing down and set on the contacts of the drone. The shortest side of the microSD card should be facing toward the back of the drone.

Tilt the metal lock over the microSD card. Press a finger gently on the lock and slide it toward the front of ANAFI USA to close and lock it – you will feel a slight click. A closed lock icon and an arrow, located on the right of the microSD slot, confirm to you the way you must slide the lock to close it.

Retrieving photos and videos

Use a **microSD to SD card adapter** to transfer videos and photos you have taken with ANAFI USA to your computer. Slide the microSD card into the adapter and use the adapter how you would use any other SD card: access your videos and photos through a card reader or the SD card slot of your computer. Copy your videos and photos to the hard drive of your computer to edit, store, and manage your media.

- ⚠ Parrot recommends you backup your photos and videos, and you empty your microSD card after each flight, to ensure you always have available memory space to capture new still or moving images.

Compatible microSD cards

Refer to Parrot online documentation for an updated list of compatible microSD cards.

Direct media retrieval (drone to computer)

You can also retrieve your media directly from ANAFI USA, without extracting the microSD card.

Use an enclosed USB-A to USB-C cable to connect the drone (USB-C) to a USB-A port of your computer. Power **ANAFI USA** on.

ANAFI USA mounts as any other external drive: copy your media from the DCIM/100MEDIA directory to your computer's hard drive.

When you are done managing your media, eject **ANAFI USA** as any other external drive.

- ⚠ When plugged in to a computer and powered on, ANAFI USA's battery discharges itself. This means you must recharge your smart battery after you have retrieved your media, even if it was fully charged when you began the procedure.

FreeFlight 6 Gallery

Finally, you can manage your media and download them directly from ANAFI USA to your device with the Gallery of FreeFlight 6.

The Gallery also lets you:

- preview videos, without downloading them to your device;
- create panoramas (refer to the "Creating panoramas" section of this guide for additional details);
- format a microSD card;
- encrypt a microSD card (refer to the next sections of this guide for additional details).

To access the Gallery from the homepage of FreeFlight 6, either tap the "microSD card" box, on the top bar of the interface, or tap the "Gallery" box, at the center of the interface.

If ANAFI USA is powered on and connected to the device (directly or through the Parrot Skycontroller 3, the FreeFlight 6 Gallery displays the microSD card media, by default.

Tap any media to preview it.

Tap any green media download box to transfer the corresponding media to your device.

Access the media you have downloaded to your device by tapping the "Local" box, at the top of the interface.

MicroSD card formatting

Tap the "Format SD card" button of the SD Card screen of FreeFlight 6 Gallery to access formatting options. Select one of the following options.

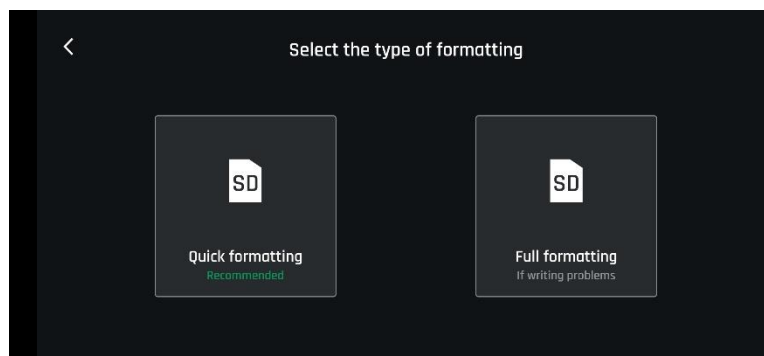

Confirm your selection from the next screen to launch the formatting.

Note that both options delete all microSD card contents, including flight data.

MicroSD card encryption

Tap the “Encrypt SD card” button of the SD Card screen of FreeFlight 6 Gallery to access the encryption profile creation page.

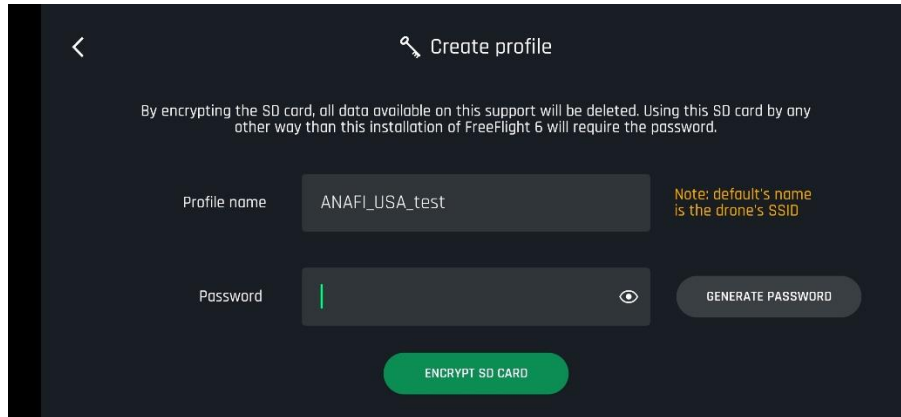

Confirm or type a profile name.

Type your own Password or tap “Generate Password”.

Tap “Encrypt SD Card” to launch encryption.

⚠ Remember encrypting a SD card deletes its content, as formatting it does.

The following screen confirms an Encryption profile has been applied to the SD card.

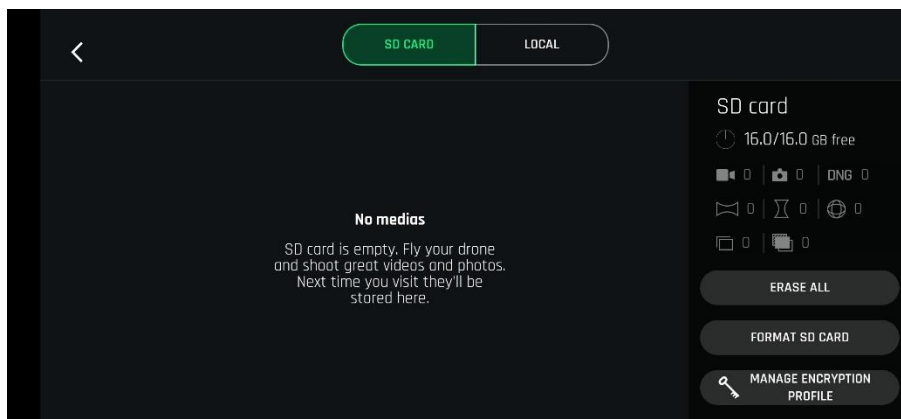

INTRODUCING FREEFLIGHT 6

The HUD (head-up display) interface of FreeFlight 6 is the ultimate companion to ANAFI USA. It enables you to access all the outstanding features of ANAFI USA, from the screen of your device, at the touch of your thumbs.

This section explores FreeFlight 6 functions, starting with a presentation of the top and bottom bars of the HUD (iOS and Android).

Access the HUD by tapping "FLY" on the bottom right of the homepage of FreeFlight 6.

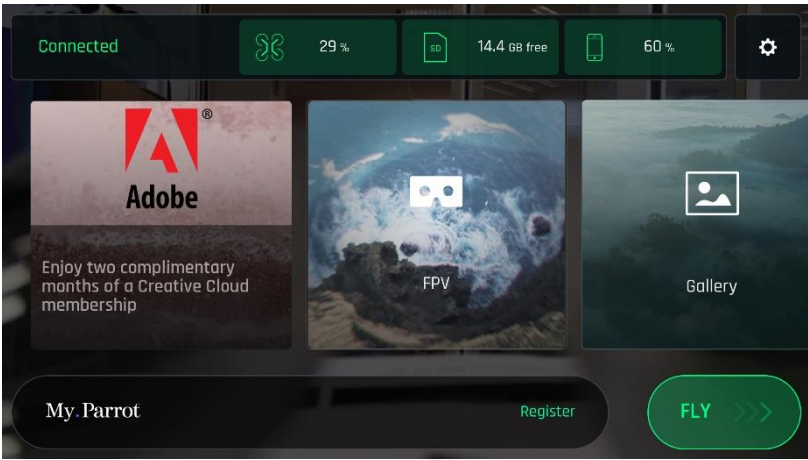

iOS FreeFlight 6 homepage

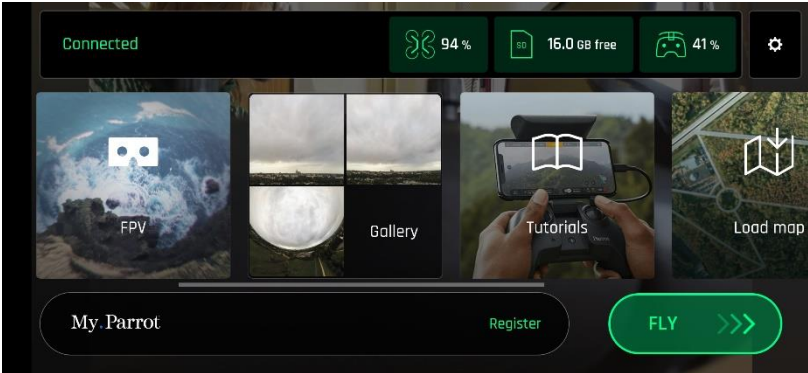

Android FreeFlight 6 homepage

Presentation of the iOS HUD (video mode view)



ANAFI USA and FreeFlight 6 are packed with features which are accessible from the HUD. Before we present the "PREFERENCES" menu of FreeFlight 6, here is an overview of your drone's current piloting, Cineshots, Dronies, and video modes.

| | |
|--|---|
| <p>Piloting modes:</p> <ul style="list-style-type: none"> Manual flight Cameraman Follow Me Smartdronies FPV Flight Plan Touch & Fly: Waypoint & POI | <p>Cineshots:</p> <ul style="list-style-type: none"> 360° (left & right) Reveal (30 & 60m) Spiral (30 & 60m) Epic (30 & 60m) |
| <p>Video modes:</p> <ul style="list-style-type: none"> Standard Cinema Hyperlapse High-Framerate Slow Motion | <p>Smartdronies & POI Dronies</p> <ul style="list-style-type: none"> Orbit Parabola Dolly Zoom Boomerang <p>Follow Me Dronies</p> <ul style="list-style-type: none"> Orbit Parabola Tornado Boomerang |

The Android HUD of **FreeFlight 6** displays strictly the same information, buttons, toggles, and menus as the iOS HUD, in the same way - despite slight cosmetic differences.

- ⚠ **Note that both GPS icons are green, on both screen captures (iOS and Android screen presentations). This means that the drone's controller (Skycontroller 3 or device) and ANAFI USA are both synchronized to enough GPS, Glonass and Galileo satellites to optimize the stability of the drone, especially at higher altitudes.**

Parrot therefore recommends you always check both your FreeFlight 6 HUD's GPS icons are green (and not red), before you make your ANAFI USA take off.

Presentation of the Android HUD (photo mode view)

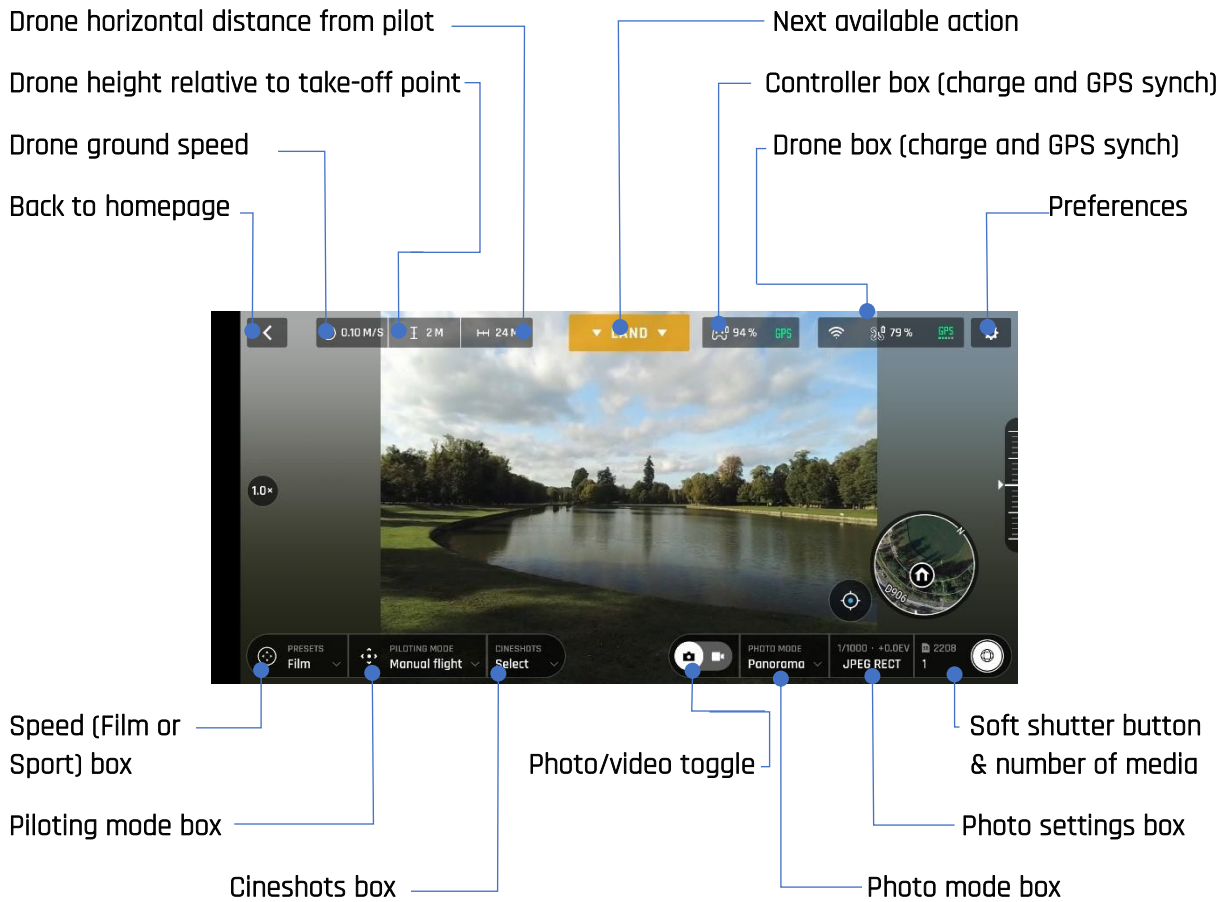

ANAFI USA's photo modes include a Single shot mode, a Burst mode, a Bracketing mode, a Timer mode and a five-format Panorama mode.

The Android HUD of FreeFlight 6 displays strictly the same information, buttons, toggles, and menus as the iOS HUD, in the same way – despite slight cosmetic differences.

⚠ Note that both GPS icons are green, on both screen captures (iOS and Android screen presentations). This means that the drone's controller (Skycontroller 3 or device) and ANAFI USA are both synchronized to enough GPS, Glonass and Galileo satellites to optimize the stability of the drone, especially at higher altitudes.

Parrot therefore recommends you always check both your FreeFlight 6 HUD's GPS icons are green (and not red), before you make your ANAFI USA take off.

PREFERENCES

Access **FreeFlight 6** preferences through the icon on the extreme right of the top bar of the homepage, or that of the HUD. Preferences enable you to fine-tune **ANAFI USA** to your hand – to customize it, to fit your piloting and filming styles.

Access Preferences submenus from the boxes on the left of the screen. Tap a box to select it and access its items.

For all items, **default values (DV)** are marked in **bold characters**.

Controls

The Controls preferences set the way you controller behaves. It also enables you to activate the “Hand-launch” option.

Tap an item option to select it.

| | |
|--------------|--|
| Control mode | CLASSIC / ARCADE (only available in flight) |
| Inverse joys | OFF (white) / ON (green) |
| Special | OFF (white) / ON (green) |
| EV Trigger | OFF (white) / ON (green) |
| Hand-launch | NO / YES |

About EV Trigger: when activated, the EV Trigger enables you to control the EV (exposure value) directly from the zoom (right) trigger of the **Parrot Skycontroller 3** (refer to the *“PARROT SKYCONTROLLER 3 PRESENTATION”* section of this guide for additional information). With this setting, you can therefore manually modify your EV from -3.0 to +3.0 by increments of 0.3, which automatically impacts the shutter speed (“s” value) of the camera.

Tap “RESET ALL CONTROL PREFERENCES” on the bottom of the page to reset preferences.

Presets

The Preset preferences allow you to adapt the flight behavior of **ANAFI USA** for each of four modes (“FILM”, “SPORT”, “CINEMATIC” and “RACING”).

Tap an item option to select it.

| | |
|-------------------|--|
| Global reactivity | 1% to 100% (DV: 15% for FILM & CINEMATIC ; 20% for SPORT ; 30 % for RACING) |
| Horizon | FIXED / DYNAMIC (DV: FIXED for FILM & SPORT ; DYNAMIC for CINEMATIC & RACING) |
| Camera tilt speed | 1°/s to 180°/s (DV: 10°/s for FILM & CINEMATIC ; 20°/s for SPORT & RACING) |
| Banked turn | NO / YES (DV: YES for FILM, CINEMATIC & RACING ; NO for SPORT) |
| Inclination | 1°/s to 40°/s (DV: 10°/s for FILM ; 20°/s for CINEMATIC ; 25°/s for SPORT & RACING) |
| Vertical speed | 0.1m/s to 4m/s (DV: 1m/s for FILM ; 2m/s for SPORT ; 2.5m/s for CINEMATIC ; 3m/s for RACING) |
| Rotation speed | 3°/s to 200°/s (DV: 10°/s for FILM ; 20°/s for SPORT & CINEMATIC ; 40°/s for RACING) |

About horizon and Banked turn: refer to in-app information for details about these features.

- ⚠ **Note that “Global reactivity”, “Inclination”, “Vertical speed” and “Rotation speed” values are the ones which carry the biggest impact on ANAFI USA’s acceleration and general flying behavior. Corresponding sliders turn to orange instead of green to warn users the settings they have selected require extreme care, superior piloting skills, or both, when flying ANAFI USA. Your drone will always remain outstandingly responsive, but with extreme settings, it will accelerate much more rapidly than you can imagine: you have been warned!**

Tap “RESET ALL PRESETS PREFERENCES” on the bottom of the page to reset the corresponding Mode to its default values. In other words, you must tap “RESET ALL PRESETS PREFERENCES” in each Mode to revert all Modes to their default values.

Thermal

The **Thermal** preferences deal with specific thermography settings.

Tap an item option, use “<” or “>” and “+” or “-” to change values.

- Color gradient **Fusion** / Rainbow / White Hot / Black Hot
- Thermal post-processing **NO** / **YES**
- Thermal sensor calibration **AUTO** / **MANUAL**
- Temperature range **DEFAULT** / **VERY HIGH TEMPERATURES**

About Thermal post-processing: **NO** is recommended for real time operations; **YES** is recommended for post flight analysis operations – refer to in-app information for details.

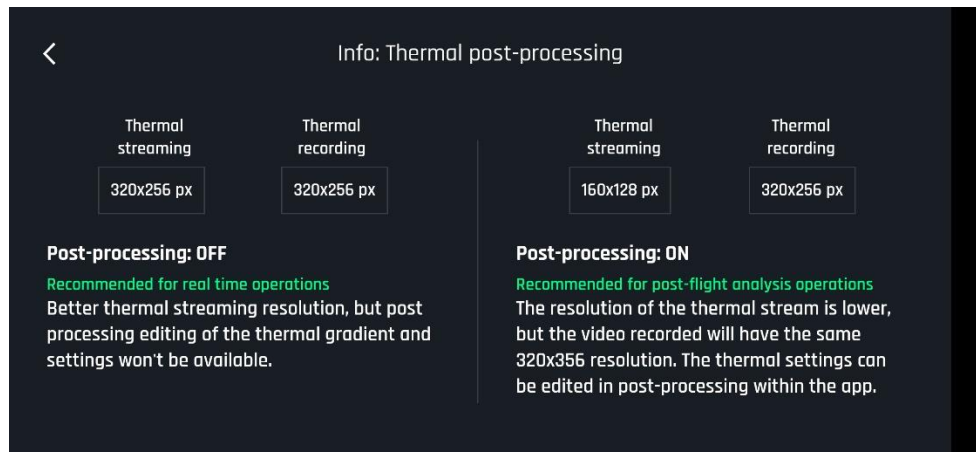

About Thermal calibration: **AUTO** mode is recommended for most users. If you select the **MANUAL** mode, note that the application will periodically remind you to calibrate your thermal camera, through the dedicated  button of your HUD.

Tap “RESET THERMAL SETTINGS” on the bottom of the page to reset preferences. This button also reinitializes thermal Spot and Absolute scales to default values, as well as visible and thermal images blending.

Interface

Interface preferences set the amount of information which appear on your **FreeFlight 6** HUD.

| | |
|----------------------|---|
| Show minimap | NEVER / WITH CONTROLLER / ALWAYS |
| Display GPS position | YES / NO |
| Coordinates system | LATLNG / MGRS / UTM / DMS |
| Map type | MAP / SATELLITE / HYBRID |
| Show framing grid | NO / 3x3 / 6x6 |
| Measurement system | AUTO / IMPERIAL / METRIC |
| FPV Goggles | Tap " CHANGE " to access the following options: Parrot - CockpitGlasses 1 / Homido Parrot - CockpitGlasses 2 / Merge VR Parrot - CockpitGlasses 3 / BNNext Google - DayDream View / Skillkorp VR5 Homido V2 / Zeiss VR One Homido Prime |

Tap "**TEST**" to verify the rendering of your selection.

About Coordinates systems: LATLNG stands for latitude and longitude; the Military Grid Reference System (MGRS) is NATO's geocoordinate standard; UTM stands for Universal Transverse Mercator; DMS (or D°M'S") stands for degree, minute, second (of arc).

Tap "RESET ALL INTERFACE PREFERENCES" on the bottom of the page to reset preferences.

Safety

Through Safety preferences, you can set a safe and clear flying area for **ANAFI USA**.

Set **ANAFI USA**'s maximum flight altitude with the "Max altitude" slider.

To set a maximum distance from the pilot for your drone, move the "Max distance" slider to the required value.

When the Geofence is activated, ANAFI USA will automatically stop when it reaches the maximum altitude or the maximum distance you have selected: a red prompt will also appear on your HUD.

| | |
|---------------------------------|--------------------------------|
| Geofence | NO / YES |
| Max altitude | 1m to 150m (DV: 30m) |
| Max distance | 10m to 4 km (DV: 300m) |
| Minimum altitude when using RTH | 20m to 100m (DV: 30m) |
| End behavior | HOVERING / LANDING |
| Hovering altitude | 1m to 10 m (DV: 2m) |
| Advanced RTH settings | NO / YES |

Note: By activating advanced RTH features, if you select return to Pilot or Custom position, the drone might not be able to reach its destination in case of low battery. Parrot will not be held responsible in case the drone lands in a different location.

Return position

TAKE-OFF / PILOT / CUSTOM

Tap "RESET ALL SAFETY PREFERENCES" on the bottom of the page to reset preferences.

Camera

Camera preferences enable you to select camera options, both in photo and video modes.

| | |
|---------------------------|--|
| Camera calibration | Tap "CALIBRATE" to access "Correct horizon", "Gimbal calibration" and "Cameras alignment" features |
| Auto record from take-off | NO / YES (video only) |
| Display overexposure | NO / YES |
| Anti-flickering | NO / AUTO / 50Hz / 60Hz |

About correct horizon: only resort to the "Correct horizon" and the "Cameras alignment" procedures if you notice your videos and photos are systematically tilted on the same side or if your visible and thermal cameras are misaligned. Refer to the "Camera calibration" section of this guide for the detailed procedure.

About Overexposure display: when this setting is activated, the HUD of FreeFlight 6 shows all overexposed areas of the screen as hatched, which enables you to fine-tune your framing, your EV settings, or both.

About Anti-flickering: this setting and the associated technology aim at eliminating the flicker effect which can arise due to some artificial lights. The "AUTO" option should work for most users, but depending on your country, you can try other settings if you feel bothered by a flicker effect on your device's screen, your artificial light videos, or both.

Tap "RESET ALL CAMERA PREFERENCES AND SETTINGS" on the bottom of the page to reset preferences.

Network

Network preferences let you change your ANAFI USA's Wi-Fi network name, password, and band.

- Broadcast DRI OFF / ON
- Network's name Tap the field to change your ANAFI USA's network name
- Password Tap the field to change your network's password
- Wi-Fi band AUTO / MANUAL

About Direct Remote Identification (DRI): the DRI system makes your drone locally broadcast information about itself for regulatory compliance (where applicable).

VIDEOS AND PHOTOS

ANAFI USA is equipped with a state-of-the-art 3-axis-stabilized gimbal, which delivers astoundingly sharp motion and still pictures, through two 1/2.4" CMOS 21MP sensors.

The lenses of the cameras include low dispersion aspherical elements, that reduce chromatic aberrations and flare, and guarantee optical excellence to such a small, smart and versatile airborne imaging system.

Although you can film and take pictures using your device as ANAFI USA's only controller, we recommend you always use the Parrot Skycontroller 3 and your device, for the best controlled, most precise, and safest filming and photos-shooting flights.

Making videos

By default, ANAFI USA and FreeFlight 6 are set to start recording a video as soon as ANAFI USA takes off. This literally means all you have to do, to start filming, is to fly ANAFI USA into the sky!

However, depending on your filming objectives, ANAFI USA and FreeFlight 6 offer a wealth of settings, from full auto to manual professional options, for you to make the most of every situation.

If required, tap the photo/video toggle in the middle of the bottom bar of the HUD, to circle the film camera (right icon) in white.

Main filming options are twofold, and accessible from the HUD of FreeFlight 6.

- **First**, select a **video mode** by tapping the corresponding box of the HUD. The options appear on your device, as they do on the screen capture below. Tap a video mode to select it and tap the **video mode** box again to confirm your choice.

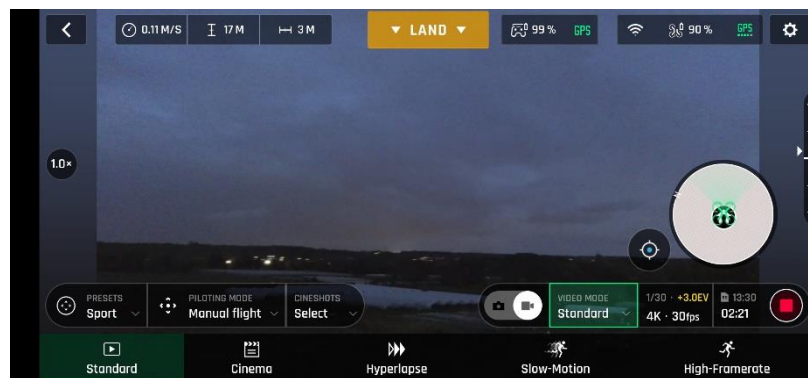

Android Video mode menu

- **Second**, select a **video resolution and a framerate (fps - frames per second) value** from the corresponding box of the HUD. Tap the **video settings** box to call the individual **video resolution** and **fps** boxes.

Tap the **video resolution box** to access the available video resolutions and tap one to select it.

Tap the **fps box** to access the available fps values and tap one to select it.

Tap the **video settings box** again to close the sub-boxes and confirm your choices.

Available video resolutions and fps values depend on the video mode you have selected:

| | |
|--------------------------|---|
| Standard: | all-round 4K, 2.7K or 1080p filming, at 24, 25 or 30fps . |
| Cinema: | spectacular 4K cinema filming, at 24fps . |
| Hyperlapse: | time-lapse video with a configurable speed factor (x15, x30, x60, x120, x240), in 4K, 2.7K or 1080p , exported at 24, 25 or 30fps . |
| Slow-Motion 1080p | filming at 48, 50 or 60fps , automatically slowed down by a factor of 2 (x0.5) and exported at 24, 25 or 30fps. |
| Slow-Motion 720p | filming at 96, 100 or 120fps , automatically slowed down by a factor of 4 (x0.25) and exported at 24, 25 or 30fps. |
| High-Framerate: | 1080p filming at 48, 50 or 60fps (ideal for post-processing) and 720p filming at 96, 100 or 120fps . |

In the following screen capture, **Standard video mode** is activated: available video resolutions are **4K (UHD), 2.7K** and **1080p (FHD)** – either in **24, 25** or **30fps**, which you would find out by tapping "30 fps" on the bottom right of the screen.



iOS Standard video format menu

When you are happy with your settings and your framing, press the hard shutter button on the right of **Parrot Skycontroller 3** (or tap the soft shutter button of the HUD) to start filming.

The soft shutter button of the HUD animates and displays a cycle between red square, and red circle. The timer starts running.

Press the hard shutter button of the controller (or tap the soft shutter button of the HUD) again to end the recording. The soft shutter button of the HUD comes back to steady, red and round. The timer resets.

Taking photos

To access the photo camera of ANAFI USA, tap the photo/video toggle in the middle of the bottom bar of the HUD, to circle the photo camera (left icon) in white.

Five photo modes are available on ANAFI USA: Single shot, Burst, Bracketing, Timer and Panorama (5 formats).

Thanks to its 21MP CMOS sensors, ANAFI USA produces three main picture formats:

- **rectilinear JPEG** (up to 16MP);
- **wide 21MP JPEG and DNG** (Digital NeGative: Adobe open standard RAW format)
- **composite panoramas** (JPEG), up to 32MP

Main photography options are accessible from the HUD of FreeFlight 6.

- **First**, select a **photo mode** by tapping the corresponding box of the HUD. The options appear on your device. Tap a photo mode to select it and tap the **photo mode** box again to confirm your choice.

When the **"Single"** mode is selected, the soft shutter button of the HUD appears as a full white circle.

When the **"Burst"** mode is selected, the soft shutter button of the HUD displays the Burst icon inside a white circle.

Selecting the **"Bracketing"** mode opens three options: 3 photos (-1 EV, +0.0 EV, +1 EV), 5 photos (-2 EV to +2 EV) and 7 photos (-3 EV to +3 EV). When one of these options has been selected, the soft shutter button of the HUD displays the Bracketing icon inside a white circle.

Selecting the **"Timer"** mode opens three options: 3 secs, 5 secs and 10 secs. When one of these options has been selected, the soft shutter button of the HUD displays "3 secs", "5 secs" or "10 secs" inside a white circle, depending on the option which has been chosen.

Selecting the **"Panorama"** mode opens three options: Vertical, Horizontal and 360. When one of these options has been selected, the soft shutter button of the HUD displays the corresponding icon inside a grey (ANAFI USA landed) or white (ANAFI USA flying) circle.

The Panorama mode is indeed the only photography mode which requires the drone to be flying before you can activate the shutter. Refer to the next section, *"Generating Panoramas"*, for additional details about the "Panorama" mode.

Selecting the “**Timelapse**” mode opens six options: 5 secs, 10 secs, 15 secs, 30 secs, 60 secs, and 120 secs. When one of these options has been selected, the soft shutter button of the HUD displays a Timelapse icon.

Selecting the “**GPS Lapse**” opens six options: 5m, 10m, 20m, 50m, 100m, and 200m. When one of these options has been selected, the soft shutter button of the HUD displays a GPS Lapse icon.

- **Second**, select a **photo format** from the corresponding box of the HUD. Tap the **photo settings box** to call the **photo settings** boxes. Tap the **last box on the right** of the screen to access the **available photo formats**.

Available photo formats for each photo mode are as follows:

| | |
|------------|---|
| Single | JPEG RECT, JPEG WIDE, DNG+JPEG (RECT or WIDE) |
| Burst | JPEG RECT, JPEG WIDE |
| Bracketing | JPEG RECT, JPEG WIDE, DNG+JPEG (RECT or WIDE) |
| Timer | JPEG RECT, JPEG WIDE, DNG+JPEG (RECT or WIDE) |
| Panorama | JPEG RECT only |
| Timelapse: | JPEG RECT, JPEG WIDE, DNG+JPEG (RECT or WIDE) |
| GPS Lapse: | JPEG RECT, JPEG WIDE, DNG+JPEG (RECT or WIDE) |

Tap a format (JPEG RECT, or JPEG WIDE if available, or DNG+JPEG if available) to select it.

Tap the photo settings box again to close the sub-boxes and confirm your choice.

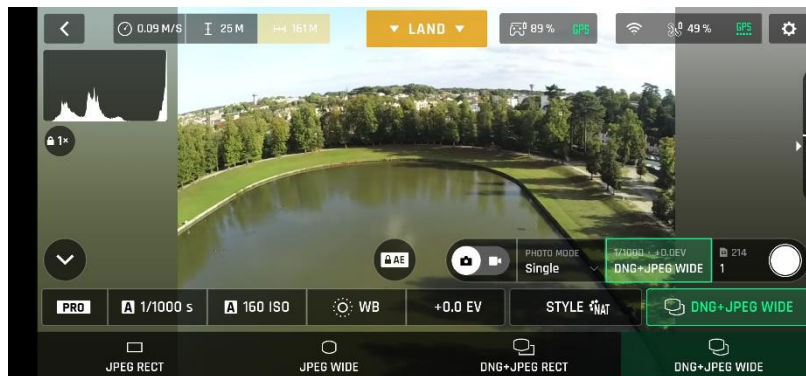

Android photo formats: DNG+JPEG WIDE

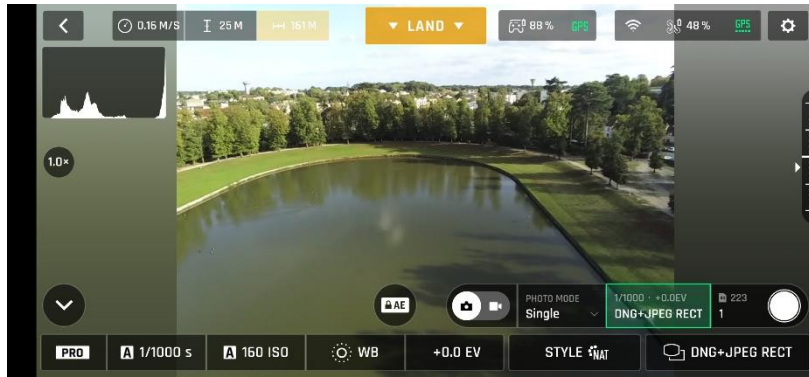

Android photo formats: DNG+JPEG RECT

In **"Single"** mode, the screen flashes white then freezes briefly in black and white to confirm a picture has been taken. The number to the left of the soft shutter button (the number of media on the microSD card) of the HUD is increased by 1.

In **"Burst"** mode, the screen flashes white then freezes briefly in black and white to confirm 14 pictures have been taken in the span of 1 second. The number to the left of the soft shutter button of the HUD is increased by 14.

In **"Bracketing"** mode, the screen flashes white then freezes briefly in black and white to confirm 3, 5 or 7 pictures have been taken. The number to the left of the soft shutter button of the HUD is increased by 3, 5 or 7, depending on your option choice.

In **"Timer"** mode, the countdown is displayed (from 3, 5 or 10 seconds) at the center of the HUD, the timer of the soft button also countdowns, then the screen flashes white and freezes briefly in black and white to confirm a picture has been taken. The timer of the soft shutter button resets. The number to the left of the soft shutter button of the HUD is increased by 1.

For additional details on the **"Panorama"** mode, refer to the next section, *"Generating Panoramas"*.

In **"Timelapse"** mode, the screen flashes white then freezes briefly in black and white to confirm a picture has been taken. 5 to 120 seconds later, depending on your option choice, the drone takes another photo, and so on until you press the shutter button again to stop the Timelapse. Between each shutter action, a green progress bar, at the bottom of the screen, serves as a countdown. At the end of the Timelapse, the number to the left of the soft shutter button reflects the total number of medias on the microSD card of the drone.

In **"GPS Lapse"** mode, the screen flashes white then freezes briefly in black and white to confirm a picture has been taken. Control and move **ANAFI USA**: when the drone reaches any point on a 5 to 200-meter bubble around the initial photo, depending on your option choice, the drone takes another photo, and so on until you press the shutter button again to stop the GPS Lapse. Between each shutter action, a green progress bar, at the bottom of the HUD, lets you estimate the distance the drone must cover before the next shot. At the end of

the GPS Lapse, the number to the left of the soft shutter button reflects the total number of medias on the microSD card of the drone.

About ANAFI USA photo formats:

- JPEG RECT: 4:3 aspect ratio, up to 16MP and 75.5° horizontal field of view (HFOV)
- JPEG WIDE: 4:3 aspect ratio, 21MP, 84° HFOV – zoom is disabled for this format
- DNG+JPEG: 4:3 aspect ratio, 21MP, 84° HFOV – zoom is disabled for this format

- ⚠ The DNG+JPEG option produces at least 2 files (1 DNG, 1 JPEG) for each shutter action. As other RAW picture formats, **DNG is a very useful format for professional photography** processing and workflow. Indeed, RAW formats retain all the information gathered by photography sensors, contrary to JPEG formats – which are compressed and processed renderings of this comprehensive information. In consequence, RAW pictures such as **ANAFI USA's DNG are heavy files, but they offer the very best post-processing and retouching possibilities.**

Creating Panoramas

ANAFI USA panoramas are generated automatically through the gallery of **FreeFlight 6**, based on a series of pictures taken by the drone.

The generation of a panorama, regardless of its format, implies three phases:

- **collecting the pictures**, in flight;
- **downloading the pictures** from **ANAFI USA** to your device;
- **stitching the pictures together** to create the panorama, on your device, through the gallery of **FreeFlight 6**.

⚠ Before shooting a panorama:

- **Make sure you are not flying lower than 10 meters (30ft) over water.**
- **Make sure no object nor subject are present in a 10 meters (30ft) radius around ANAFI USA.**
- **Bear in mind ANAFI USA locks the exposure** (refer to the "*AE Lock*" section of this guide for additional information on exposure locking) **of the frame with which you start your panorama.** For this reason, Parrot recommends you always frame the main subject of the intended panorama before pressing the shutter button.
- **Bear in mind ANAFI USA will not enable you to proceed with a panorama if the drone is short on power** (capturing a 360 Panorama takes **ANAFI USA** up to 90 seconds).

To capture a panorama, select the "Panorama" box from the "Photo Mode" menu of the HUD. Then, tap the panorama type you want to select it: **Vertical**, **Horizontal** or **360**. The soft shutter button icon reflects your choice, as on the screen capture below.



Panorama formats, Android

When you are happy with your framing, press the hard shutter button on the right of the **Parrot Skycontroller 3** (or tap the soft shutter button of the HUD) to begin the Panorama capture. **ANAFI USA** starts taking pictures and the bottom of the HUD displays a progress bar which fills with green as the capture unfolds.

⚠️ Panorama types capture characteristics:

- **Vertical:** **ANAFI USA** takes 8 photos in about 18 seconds
- **Horizontal:** **ANAFI USA** takes 10 photos in about 20 seconds
- **360:** **ANAFI USA** takes 42 photos in about 90 seconds

To download the Panorama pictures to your device, land **ANAFI USA**, access the homepage of **FreeFlight 6** and tap the **microSD card box** or the **Gallery box** to display the media present on your microSD card. Like other media, Panoramas are marked with their distinct icon and a green download box, which shows the size of the corresponding series of pictures.

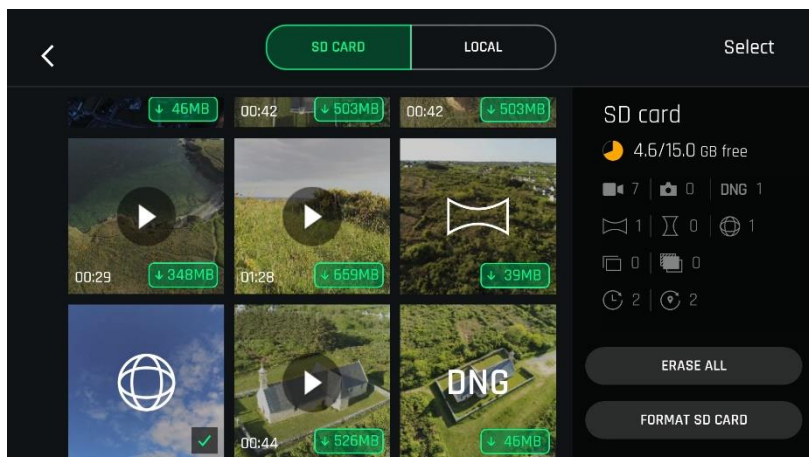

MicroSD card gallery

Tap the **green box of the Panorama you want to generate** to start downloading the corresponding series of pictures to your device. When the download is complete, **FreeFlight 6** displays a page from where you can delete the downloaded photos: tap "Yes" to keep the originals on the microSD card; tap "No" to delete them. **FreeFlight 6**

displays the Local (device) gallery, which contains only the media you have downloaded from **ANAFI USA**'s microSD card.

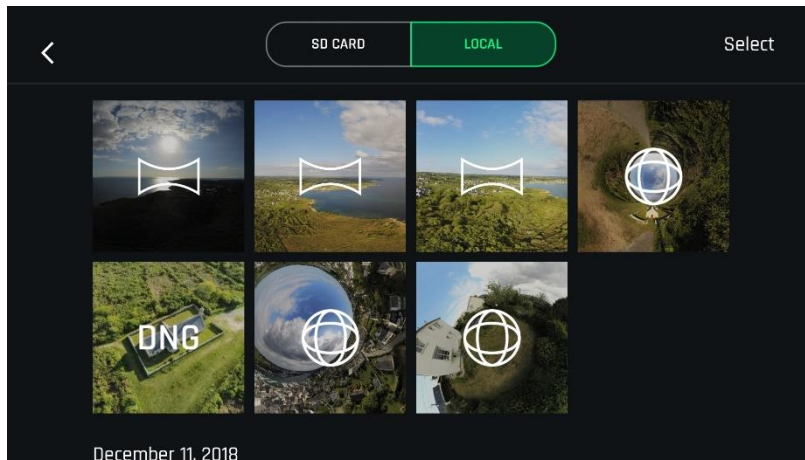

Local (device) gallery

Finally, select the panorama you want to generate from your Local gallery: FreeFlight 6 displays the following screen.

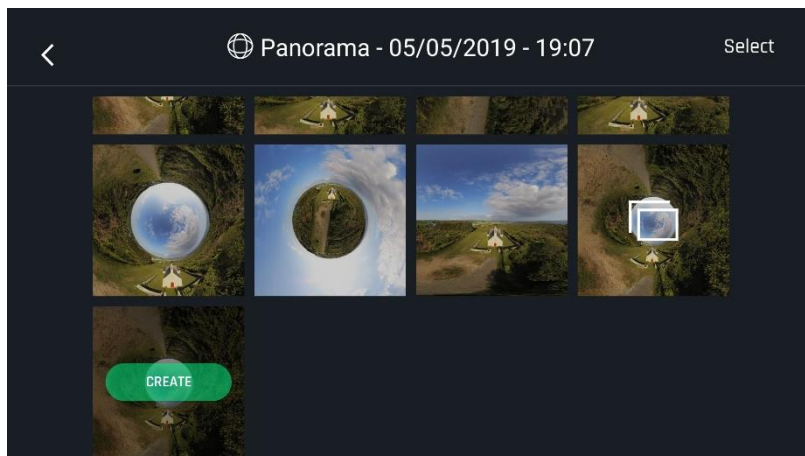

Android panorama generation page

Tap **"Create"** to generate the panorama (or tap the other icon to access the series of individual pictures).

Depending on the power of your device, **FreeFlight 6** may display one or two resolution options, up to 32 MP. Select the option you want to launch the generation. The time this process takes also depends on your device's power. For the highest quality 360 panorama (32 MP), it can take several minutes.

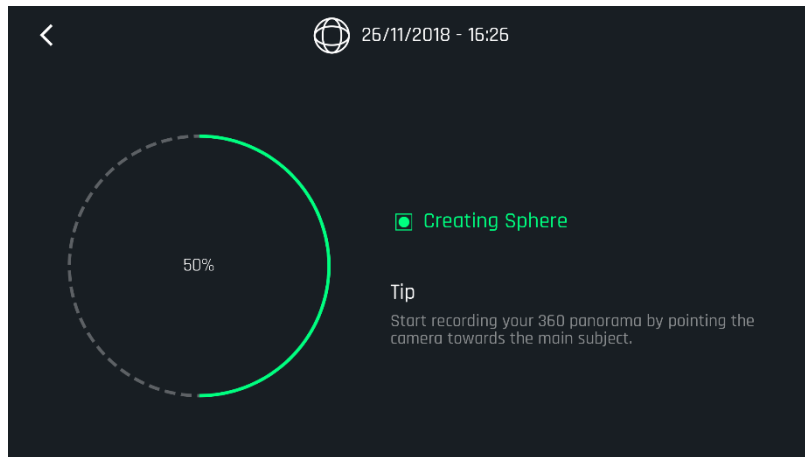

iOS: generating a Sphere panorama

When the panorama creation is complete, **FreeFlight 6** displays the panorama and gives you the option to delete the original files.

- ⚠ For each **Vertical** or **Horizontal** panorama capture, you will be able to generate one panorama only.
- ⚠ For each **360** capture, you will be able to generate three different preset panoramas (Sphere, Little Planet and Tunnel) and a potentially infinite number of custom panoramas, through the 360 editor.
- ⚠ Do not worry about stitching issues on your 360 editor screen, when you create a custom panorama: the direct rendering is a preview only. For each custom panorama you decide to create, FreeFlight 6 completely reprocesses the data to minimize stitching issues and discrepancies.



An example of custom panorama

GIMBAL TILT AND ZOOM CONTROLS

Two of ANAFI USA's main assets are its gimbal tilt control capabilities (250°), and its zoom. This section presents these features and the way to activate them.

Gimbal tilt control

ANAFI USA's gimbal tilt control is activated through the left trigger of Parrot Skycontroller 3. It is available in all video and photo modes, and in all manual piloting modes.

- To aim the gimbal toward the ground, push the tilt control trigger down.
- To aim the gimbal toward the sky, pull the tilt control trigger up.
- To reset the gimbal tilt to a horizontal position, press the optics reset button on the left of Parrot Skycontroller 3 (this action also resets the zoom factor of the lens to 1x),

Zoom control

ANAFI USA's zoom control is activated through the right trigger of Parrot Skycontroller 3. It is available in all video modes, and in JPEG RECT photo mode (with an impact on the final resolution of your pictures). WIDE photo modes imply the use and rendering of all 21MP delivered by ANAFI USA's CMOS sensors: zoom is deactivated in both WIDE photo modes.

- To zoom in on a subject, push the zoom trigger down.
- To zoom out, pull the zoom trigger up.
- Pressing the optics reset button on the left of Parrot Skycontroller 3 instantly resets the zoom factor of the lens to 1x (this action also resets the gimbal tilt to a horizontal position).

The HUD of FreeFlight 6 presents precise, decimal-by-decimal zoom information at all times, in the middle of the left side of the screen, as shown on the following screen captures - note that in these examples, ANAFI USA's gimbal is tilted all the way toward the ground.

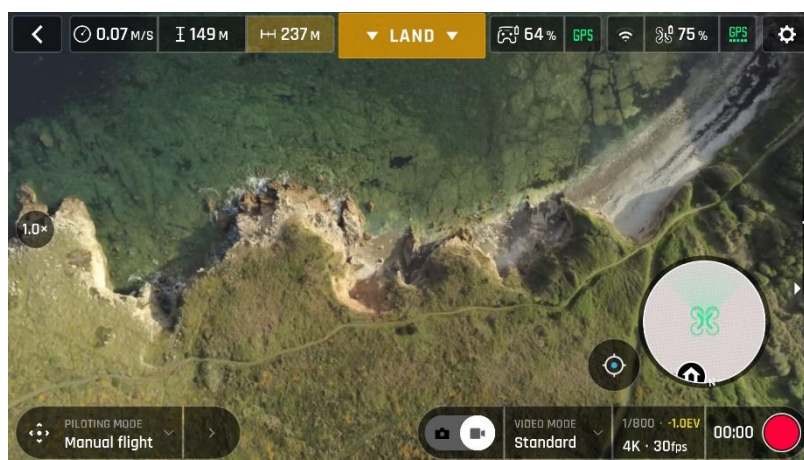

Android 4K x1 zoom

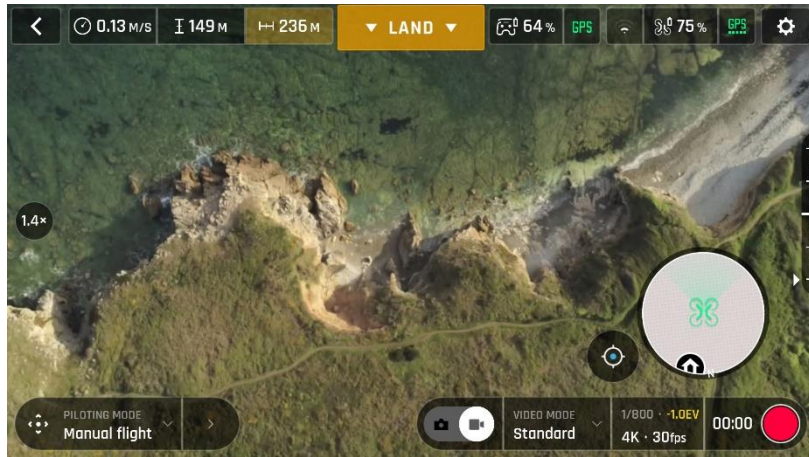

Android 4K x1.4 zoom

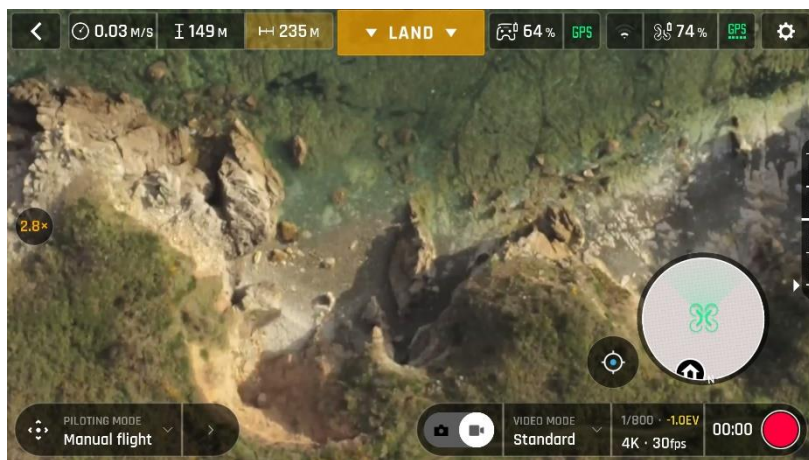

Android 4K x2.8 zoom

As already mentioned, **ANAFI USA** presents no lossless zoom capabilities for pictures: the zoom is deactivated by design in WIDE formats (JPEG and DNG+JPEG), and it has an impact on the resolution of the pictures in JPEG RECT format.

By contrast, **ANAFI USA** offers impressive lossless zoom capabilities for 4K UHD (x1.4), 2.7K (x1.9) and 1080p (x2.8) videos.

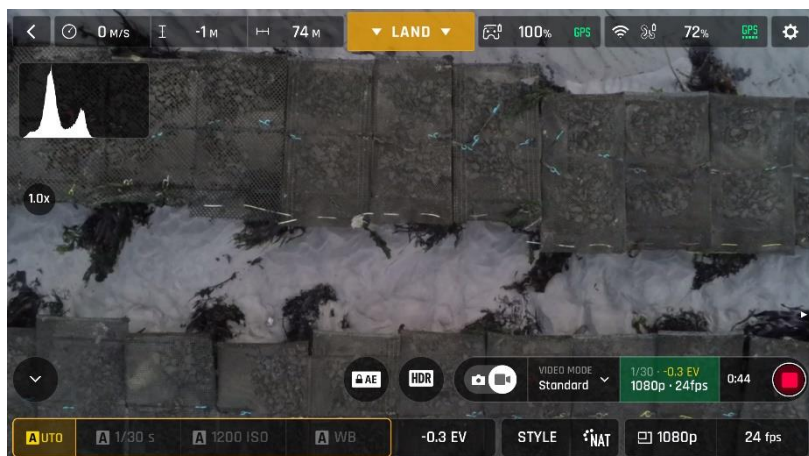

iOS 1080p x1 zoom



iOS 1080p x1.4 zoom

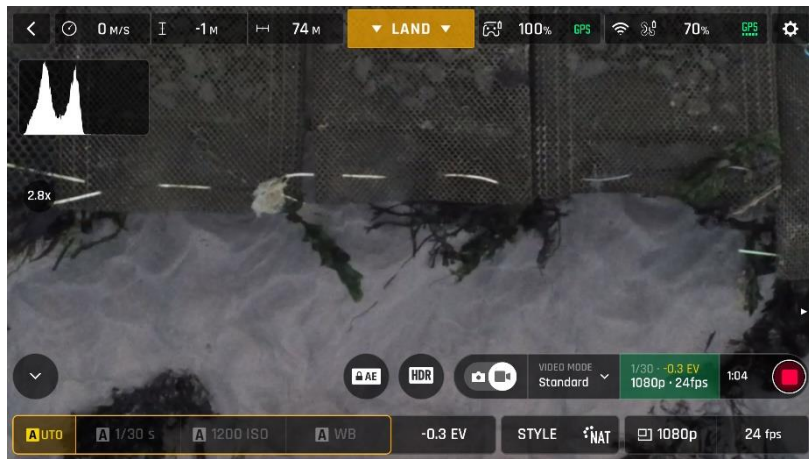

iOS 1080p x2.8 zoom

Camera Calibration: Correct horizon (exceptional procedure)

- ⚠ **Your ANAFI USA's camera has been factory-calibrated with unparalleled precision.** Unlike the calibration of **ANAFI USA** or that of the **Parrot Skycontroller 3**, which must be carried out periodically, **the camera calibration must not be carried out unless it appears necessary** - typically, after a crash.
- If you notice **a tilted horizon on all your videos and photos**, and if this **tilt is always on the same side**, access camera calibration to make your horizon perfectly straight again.

This feature is accessible from the **ANAFI USA** box on the **FreeFlight 6** homepage (or from the **ANAFI USA** box of the HUD) and from the *"PREFERENCE - Camera"* menu.

Before starting this procedure, you need to position **ANAFI USA** on a flat and perfectly level surface, exactly perpendicular to any pattern containing straight lines you can use as horizon references. A set square can help you check that a line on your floor is perpendicular to your wall, as on the following pictures.



Finding a line perpendicular to the wall



ANAFI USA ready for horizon correction

When **ANAFI USA** is correctly positioned, perpendicular to its straight horizon reference, power it on, along with the **Parrot Skycontroller 3** and your device, as you would for any flight.

Access "Camera calibration" from the **ANAFI USA** box of the homepage or the HUD of **FreeFlight 6**, or from the "PREFERENCES-Camera" menu.

Select the "Correct horizon" option from the following screen.

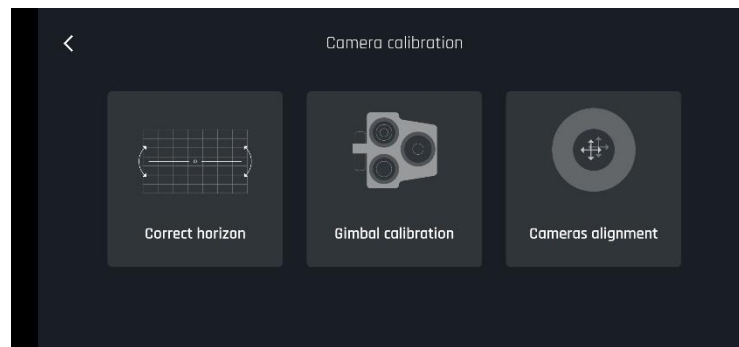

ANAFI USA: gimbal/camera calibration (Android)

The following screen appears.

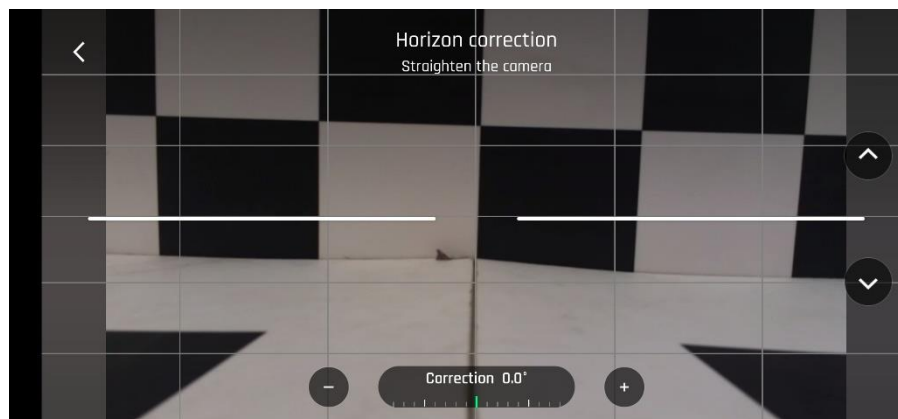

Gimbal/camera calibration: before (Android)

Tap "-" or "+" until the artificial horizon of **ANAFI USA** matches the horizon reference facing the drone. **Do not worry about vertical lines: as you can see from the screenshots, they do not appear straight or parallel on the gimbal calibration screen.**

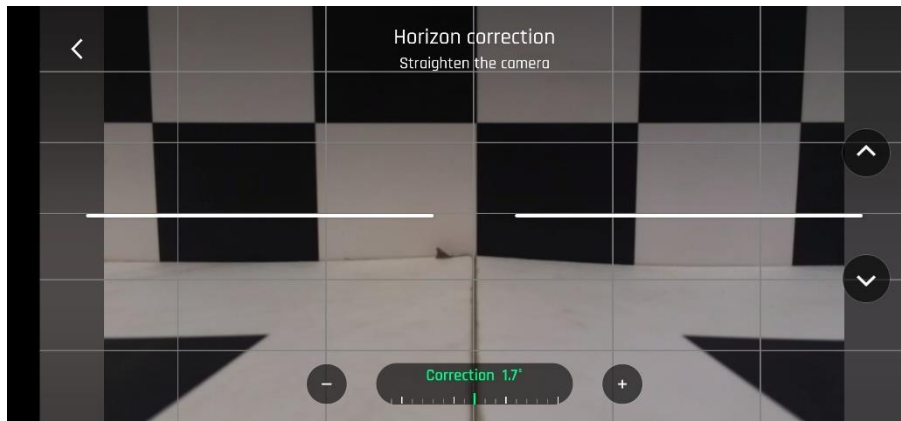

Gimbal/camera calibration: after (Android)

When you have straightened the tilt of the camera, tap the "<" icon on the top left of the screen to confirm your setting and exit camera calibration.

Camera Calibration: Gimbal calibration

Use this option to perform a gimbal calibration, similar to that which occurs after ANAFI USA is powered on.

- ⚠ Be aware that FreeFlight 6 can require you to carry out this procedure (as it can require you to perform a drone magnetometer calibration) before allowing you to fly ANAFI USA.

Camera Calibration: Cameras alignment (exceptional procedure)

Use this option to align the images of your visible and thermal spectrum cameras.

As the interface advises, due to cameras parallax, use the farthest possible object as your alignment reference.

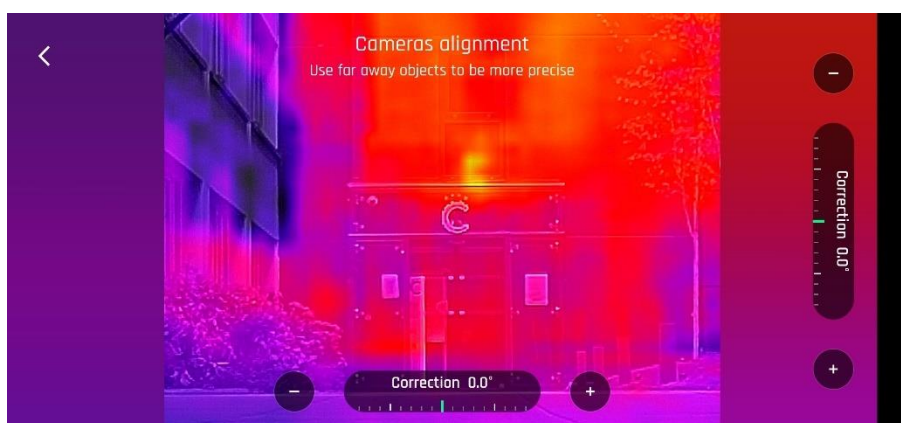

ANAFI USA: Camera alignment, before (Android)

Note that you can activate the zoom (right) trigger to magnify the view of your reference.

Tap “-” or “+” on each axis to align visible and thermal views.



ANAFI USA: Camera alignment, after (Android)

Tap “<” on the top left of the screen to exit the interface and confirm your settings.

PRO-IMAGING SETTINGS

ANAFI USA is set to deliver high quality and balanced 4K videos and 21MP photos, out of the box.

Some image enthusiasts and all professional directors, videographers and photographers, however, will find their way through pro-imaging settings. This section is designed to help you exploit manual settings and develop your filming and photography styles.

The Exposure value (EV) is the only setting accessible in the Auto mode, from the "Video/Photo settings box" menu of the HUD.

Exposure value (EV)

The EV expresses the general darkness or lightness of a photograph – or a video. At +0.0 (zero) EV, **ANAFI USA** automatically adapts the shutter speed and the ISO value to deliver a perfectly balanced photo or video: not too dark and not too light.

Tap the "+0.0 EV" box to activate the EV slider.

Slide your finger on the screen to adapt your EV toward negative values and darken your picture or video.

Use positive values to lighten your images. This can be useful if you want to capture a backlit scene and to fade surroundings in light.



-1.0 EV, iOS



+1.0 EV, iOS

To activate further settings, tap "Auto", on the far left of the Video/Photo settings box. The additional settings boxes are unlocked, they stand out in white and "Auto" has been replaced with "Pro".

Shutter speed (s)

The "s" value refers to the time, in fraction of second, when the shutter stays open to capture a still picture: it is called exposure time.

In Auto mode, **ANAFI USA** selects the best shutter speed and ISO value couple, in real time, depending on the scene and available light. In consequence, selecting a shutter speed also deactivates the Auto ISO mode.

As **ANAFI USA**'s f/2.4 aperture lenses lets a lot of light in, even compared to most professional SLR lenses, your drone can achieve very fast "s" values (down to 1/10000s) and capture very fast action. It can also be used for slow shots, up to 1 second for the photo mode.

Note that **ANAFI USA** can shoot pictures and videos when it is not flying. You can even hold it in your hand and use it as a premium stabilized 4K video and photo camera.

Tap the "s" box to open the shutter slider.

Select a value to exit the auto-mode for shutter speed and ISO. This action also deactivates the EV slider.

Set the s value you require, then tap the "ISO" box to select an ISO value. Experiment! The display of the HUD reflects your settings. If you get lost, tap Auto either on the "s" or the "ISO" slider to get back to auto exposure and reactivate the EV slider.

ISO value (ISO)

The ISO value refers to the sensitivity of the sensor. As we have seen, it is linked to the shutter speed value: both sliders activate when you deactivate the "Auto" mode and set a value for one, or for the other. The lower the ISO value, the lower the sensitivity of the sensor, and the lower the image noise (digital grain). Therefore, under good lighting conditions, such as sunny daylight outside shots, low ISO values (100 or 200) should always be selected. The sensitivity of the sensor increases as the ISO value goes up: 3200 ISO can be used to capture low light interior scenes, or exterior shots at dusk or dawn, for example.

By default, in Auto mode, **ANAFI USA** constantly adapts its ISO and shutter speed values to the scene it is filming. Setting an ISO value for a whole shot or series of shot, however, is very useful to professional filming.

Tap the ISO box to open the shutter slider.

Select a value to exit the Auto mode for ISO and shutter speed. This action also deactivates the EV slider.

Set the ISO value you require, then tap the "s" box to select a shutter value.

Experiment! The display of the HUD reflects your settings. If you get lost, tap Auto either on the "s" or the "ISO" slider to get back to auto exposure and reactivate the EV slider.

White balance (WB)

White balance deals with the color temperature of the light. Cold lights make the whites look blue. Warm lights make the whites look yellow. By default, in Auto WB mode, **ANAFI USA** keeps the whites white, at all times: it adapts its WB value in real time.

However, setting a WB value for an entire shot is especially useful for professional filming: stable WB facilitates the grading (color treatment) of videos.

Tap the WB box to open the white balance options.

Select the WB option that is best suited for your shooting conditions, your subject, or both. The display of the HUD reflects your settings and helps you make the best choice.



Auto WB, Android



Incandescent WB, Android



Fluo WB, Android



Sunny WB, Android



Cloudy WB, Android



Shaded WB, Android



WB 2 000 K, Android



WB 10 000 K, Android

HDR

HDR (high dynamic range) is another great way to enhance a video or a photo. The HDR option is available for Standard video mode 4K, 2.7K and 1080p formats (regardless of framerate values) and JPEG photos.

To activate the HDR option, select a Standard video mode or a JPEG photo format from the relevant boxes of the bottom bar of the HUD. A white and round HDR icon appears on the screen of your device, to the left of the photo/video trigger.

Tap this icon: it turns yellow and a HDR notice appears in black inside a yellow box, under the "next available action" box, at the center of the top bar of the HUD. Press the hard shutter button on your Parrot Skycontroller 3 (or the soft shutter button of the HUD) to start filming in HDR or to take a HDR photo.

Tap the round HDR icon again to deactivate HDR. The yellow HDR box disappears from the screen.



HDR Off, Android



HDR On, Android

Note that you cannot modify "s", "ISO" or "WB" values when the HDR mode is activated. However, you always keep control over your EV value.

⚠ Note that activating (or deactivating) HDR stops any ongoing video recording.

NATURAL Style

The **Natural** Style is the default ANAFI USA Style: it respects nature's colors and tones.

Activate the "NATURAL" Style from the "Style" box of the Video/Photo settings menu.

P-LOG Style

One alternative Style to Natural looking images (default value) can be selected for ANAFI USA both in the video mode, and in the photo mode. This alternative Style is called "P-LOG". It makes images a little less contrasted: P-LOG style is ideal for videos you want to edit and process using professional grading tools and filters.

Activate the "P-LOG" Style from the "Style" box of the Video/Photo settings menu.

INTENSE Style

Another alternative Style to Natural looking images (default value) can be selected for ANAFI USA both in the video mode, and in the photo mode. It is called "Intense". It makes images more saturated and contrasted.

Activate the "INTENSE" Style from the "Style" box of the Video/Photo settings menu.

PASTEL Style

Another alternative Style to Natural looking images (default value) can be selected for **ANAFI USA** both in the video mode, and in the photo mode. It is called “**Pastel**”. It makes images less saturated, but it brings out their warmest tones.

Activate the “**PASTEL**” Style from the “**Style**” box of the Video/Photo settings menu.

ADJUSTMENT

The **ADJUSTMENT** button, next to the P-LOG box, provides three additional settings for your **Normal Style** still images and films:

- Saturation: sets the intensity of the colors (from -2 to +2)
- Contrast: sets the degree of difference between lightest and darkest parts of the image (from -2 to +2)
- Sharpness: sets the distinction of the reproduction of details (from -1 to +1)

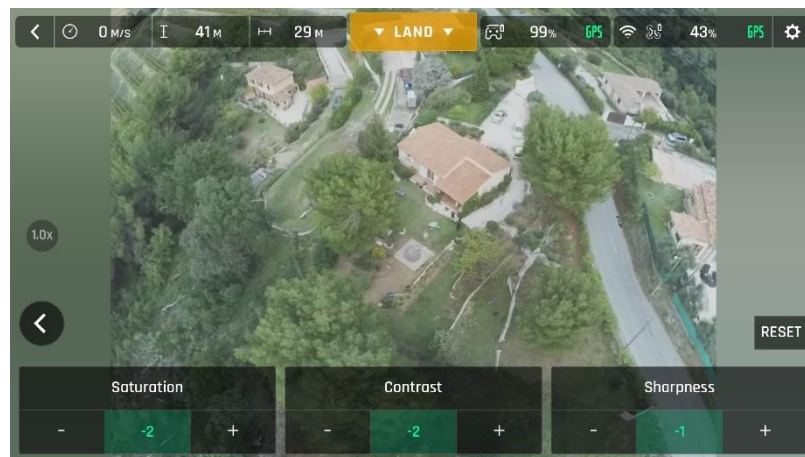

All settings at minimal values (iOS)

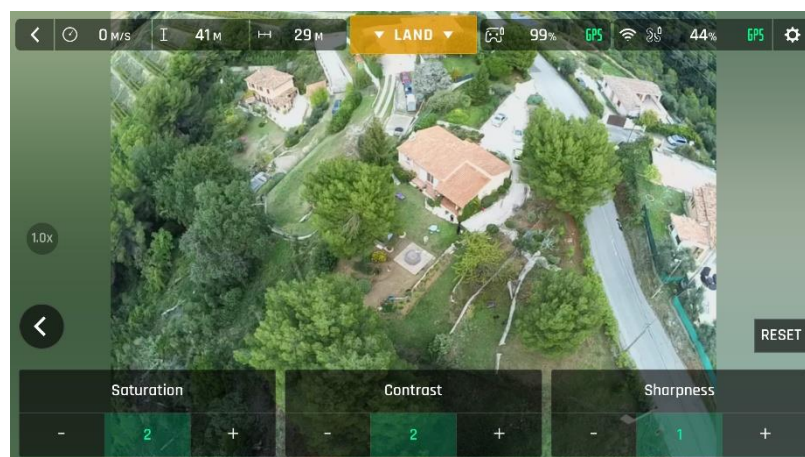

All settings at maximal values (iOS)

Tap the **RESET** button, on the right of the screen, to bring all values to 0 (zero).

Tap the "<" icon, on the left of the screen, to confirm your settings and exit the ADJUSTMENT menu.

Lock AE

Another great feature of **FreeFlight 6** is the possibility to lock the general exposure of a view, to fine-tune the framing of a shot and keep the desired exposure.

To access this function, tap the "Video settings box" (video mode) or the "Photo settings box" (photo mode) of the HUD.

A "Lock AE" icon appears, to the left of the HDR icon (it replaces the "HDR" icon in DNG+JPEG photo format, since HDR is not available with this setting).

Tap the "Lock AE" icon to lock the exposure value to that of the current view. The icon turns to yellow. A yellow "Lock AE" box appears under the "Next available action" box, at the center of the top bar of the HUD.

Move **ANAFI USA** around or tilt its gimbal to change the frame: the exposure settings remain as they were when you activated the function.

Tap the "Lock AE" icon again to deactivate the exposure lock: the icon turns back to white and the yellow "Lock AE" box disappears.

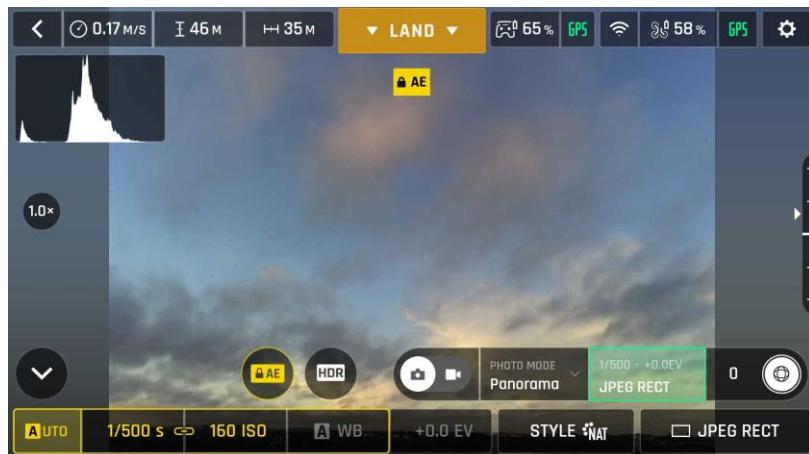

Exposure is locked on the sky (Android)

Lock AE Touch

With the “Lock AE Touch” (or “Spot AE”) function of FreeFlight 6, you can also lock the exposure of a frame on any detail of any view.

To activate this function, follow the “Lock AE” procedure of the preceding section. When the exposure is locked, touch the part of the frame you want to base your exposure on. A yellow square animates around this spot and the yellow “Lock AE” box is replaced by a yellow “Lock AE Touch” box.

Refer to the following screen captures for additional details on the logic of this great feature.

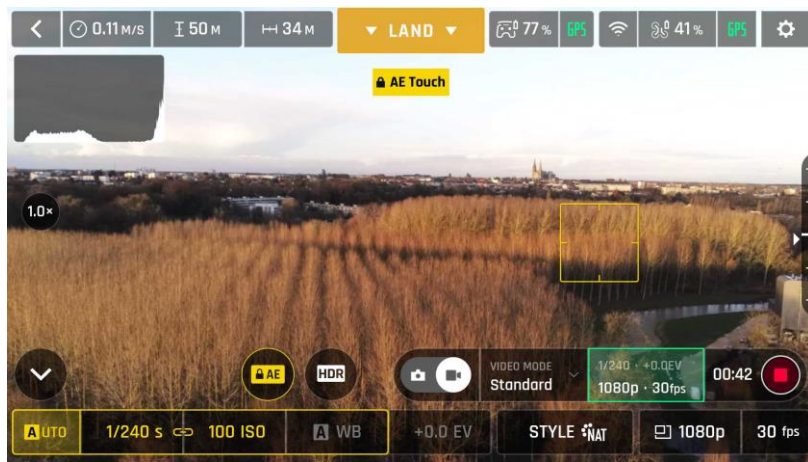

Exposure is locked on the top of the trees (Android); shutter speed is set at 1/240 s

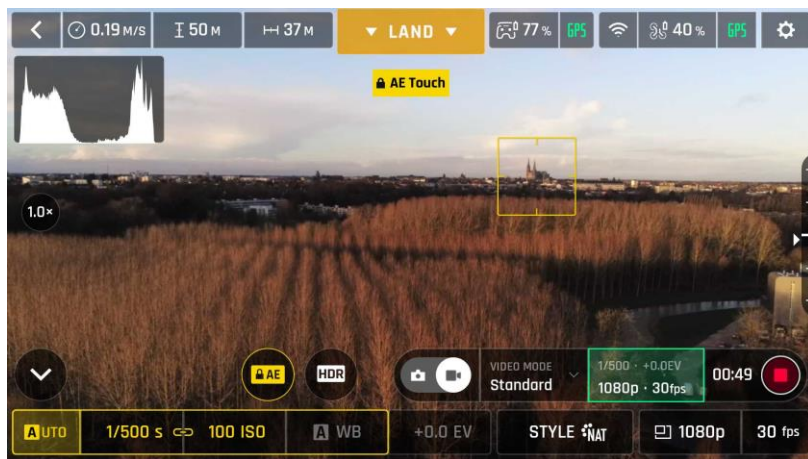

Exposure is locked on a building on the horizon (Android); shutter speed is set at 1/500 s

THERMAL IMAGING

About Thermal Imaging

Thermal imaging – or infrared (IR) thermography – is the process of acquiring, measuring and analyzing thermal information from non-contact devices, such as **ANAFI USA's** FLIR Boson camera.

Thermal imaging devices transform invisible IR radiations, or heat transfers, into colored images the human eye can interpret and analyze.

To access **ANAFI USA's** thermography mode, either tap the “THERMAL” box on the homepage of **FreeFlight 6** or tap the “SPECTRUM” box on the lower bar of the HUD and select “Thermal”.

Presentation of the Thermal HUD (post-processing)

Spectrum blending
(the thermometer icon indicates only the IR spectrum is displayed)

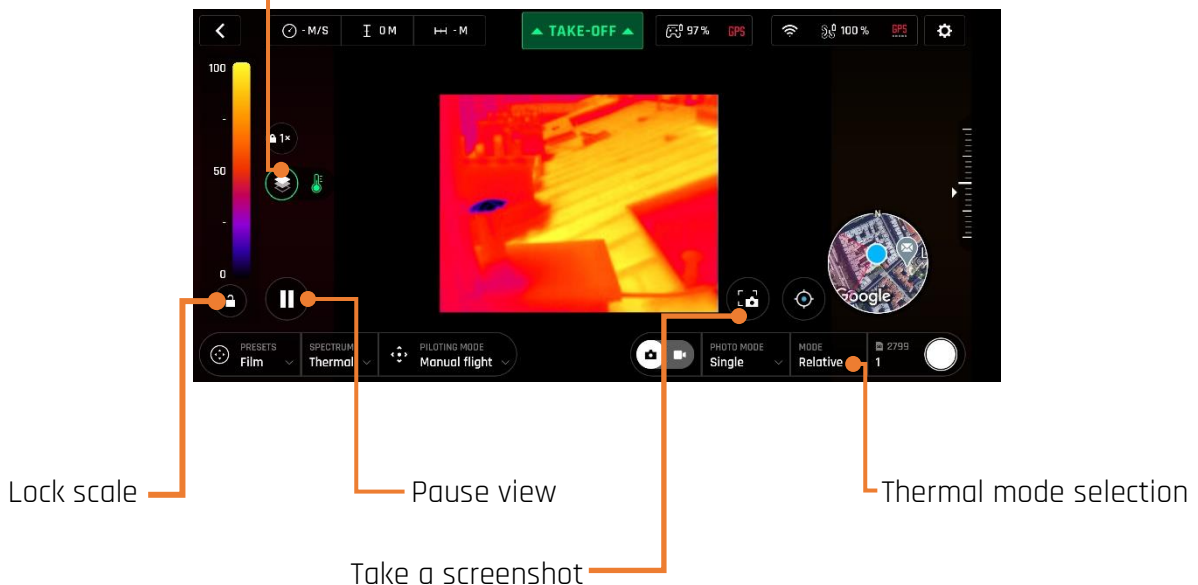

⚠ **Note that when post-processing is activated (default value), the “Pause view” and “Lock scale” buttons are available** – they disappear when post-processing is deactivated (refer to the *“PREFERENCES - Thermal - Thermal post-processing”* section of this guide for further information on thermal post-processing).

As for the Visible Spectrum, you can record both **Thermal photos and videos**: make your choice through the photo/video toggle button in the lower bar of the HUD (or among additional settings, as in the Thermal HUD screen capture).

When in Thermal Spectrum, **the choice of photo modes is limited to three options**, each of which delivering 1280x720 rectilinear JPEG thermography images:

- Single shot
- Timelapse (10, 30, 60, 120 or 240 seconds intervals between shots)
- GPS Lapse (5, 10, 20, 50, 100 or 200 meters spherical intervals between shots)

The **Thermal Spectrum video mode is limited to a single option: ANAFI USA** shoots 9 frames per second 1280x720 thermography MP4 (H264) videos.

You can always **capture screenshots**, directly to your device, through the dedicated screen button. This feature is especially useful when filming, as it enables you to extract a still image from a film without stopping the recording.

⚠ **ANAFI USA** is a multicamera system (two EO lenses for one visible camera, one thermographic camera). However, photo or video mode selection is independent from the cameras. In other words, for example, switching from Visible Spectrum photo mode calls the last Thermal Spectrum photo mode that was selected; similarly, switching from Thermal Spectrum video mode calls the last Visible Spectrum video mode that was selected.

Relative Thermal mode

The Relative mode is the default thermography mode of **ANAFI USA**, which is activated upon first access to the Thermal HUD.

The Relative mode is useful to get a quick overview of any scene's temperature range. In this mode, even slight heat differences materialize as strong contrasts.

Its main specificity is that the scale it displays, on the left of the HUD, matches by default the temperature range of the scene **ANAFI USA** is filming, on a 0 to 100 graduated scale.

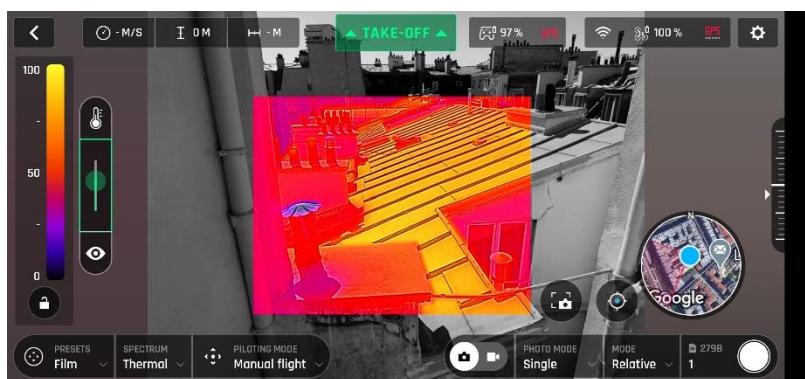

*Relative Thermal mode
(balanced blending between IR and visible)*

However, when the post processing is activated, the lock button enables you to temporarily **lock the scale to the temperature range of any scene**. This is especially useful if you must reframe your scene to include part of the sky. Indeed, the sky always appears as a very cold element, which disturbs the scale.

Spot Thermal mode

The Spot Thermal mode of ANAFI USA is especially useful to isolate cold or hot spots.

Use the **inverted arrows button** (under the scale, on the left of the screen) to toggle from hot to cold (or from cold to hot) and **slide your finger along the scale** to adapt the threshold of the scale to your scene and highlight only coldest or hottest spots.

Spot Thermal mode: only the hottest elements of the scene are colored.

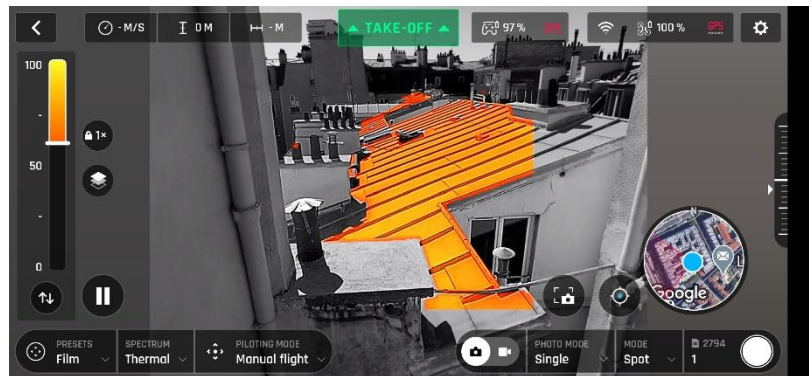

Note that in Spot Thermal mode, the thresholds you set manually are only reset when you tap the “RESET THERMAL SETTINGS” button in the Thermal Preferences tab.

THERMAL ANALYZER MODE

The Thermal analyzer feature of **FreeFlight 6** provides you with a great tool to achieve quick thermal analysis, directly from your device.

This function gives you full control over the on-screen rendering of any thermography video or photo you have taken with **ANAFI USA**. From the analyzer, you can:

- access Thermal Preferences directly from the preview's Preferences icon, top right;
- navigate inside your thermography videos;
- modify the thermography modes (Relative, hot and cold spots) and their associated thresholds at any point of any video or on any photo;
- modify the blending between Visible and Thermal spectrums;
- save as many screenshots as you want.

However, Thermal analyzer videos cannot be saved or exported by **FreeFlight 6** – even if most devices enable you to record your screen.

To analyze a thermography media, access your **Local FreeFlight 6 Gallery** and open a thermal video preview or a photo.

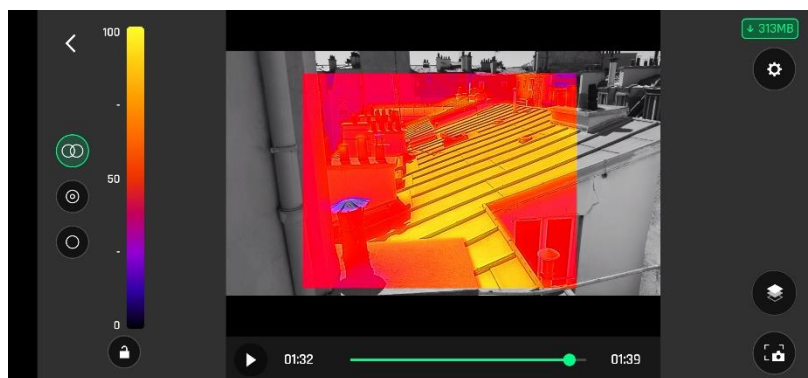

Thermography video preview, Relative mode (Android)

Tap the green "ANALYZE" box.

The photo displays or the video plays in Analyzer mode. As shown on the following screen captures (extracted from a video analysis), the interface gives you access to most options available for filming.

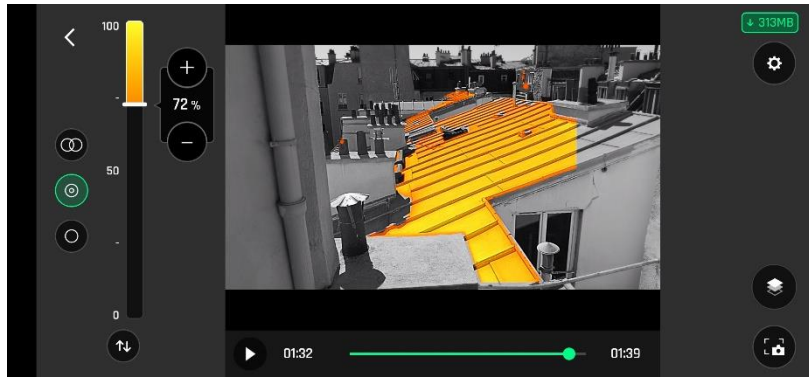

Same image, (hot) Spot mode (Android)

CINESHOTS (VISIBLE SPECTRUM ONLY)

ANAFI USA features a series of automated shots, which enable you to capture scenes professionally.

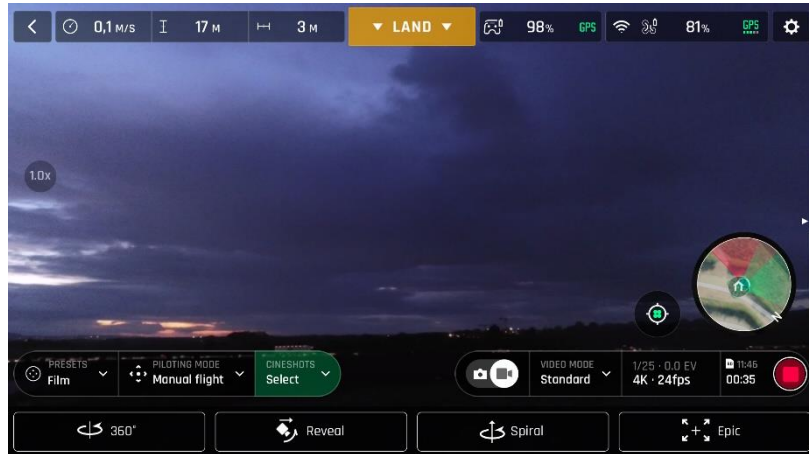

iOS Cineshots menu

Make sure you have selected the video settings you require and tap "CINESHOTS" in the bottom bar of the HUD to access Cineshots. Tap a Cineshot to select it. For each, two options appear. ANAFI USA films all your Cineshots automatically – provided you have free space on your microSD card.

360°

The 360° Cineshot is self-explanatory: when it is activated, **ANAFI USA** maintains its position and altitude, and rotates slowly and completely around its axis to uncover a full panorama.

Tap "Right" or "Left" to select the direction you want your drone to rotate, and to activate the 360°. After a countdown on the HUD, **ANAFI USA** starts its rotation. An animation flashes on the screen of your device, and the "360°" box progressively fills with green as the Cineshot unfolds.

Reveal

The Reveal Cineshot is a classic motion picture opening shot: when it is activated, **ANAFI USA** tilts its camera toward the ground and starts moving forward in a straight horizontal line. Slowly, over 30 or 60 meters, the camera gimbal tilts up, revealing the scenery in front of **ANAFI USA**.

Before you activate the Reveal Cineshot, check the area in front of **ANAFI USA** is clear from obstacles, and safe.

Tap "30m" (small-arrow icon) or "60m" (large-arrow icon) to select the range of your Reveal shot, and activate it. After a countdown on the HUD, **ANAFI USA** tilts its camera down and starts moving forward. An animation flashes on the screen of your device, and the "Reveal" box progressively fills with green as the Cineshot unfolds.

Spiral

The Spiral Cineshot is perfect to unveil your surroundings – or that of any object on the ground. When it is activated, **ANAFI USA** tilts its camera to the ground and starts moving up, in a straight vertical line. Slowly, as it climbs to 30 or 60 meters, **ANAFI USA** carries out a full 360° rotation around its axis, then its camera tilts up progressively, panning over the scenery along a 180° rotation. Therefore, **ANAFI USA** finishes the Spiral Cineshot with a 180° angle, compared to its starting point.

Before you activate the Spiral Cineshot, check the area beyond ANAFI USA is clear from obstacles, and safe: do not activate the Spiral Cineshot under trees, or a bridge, for example.

Tap “30m” (small-arrow icon) or “60m” (large-arrow icon) to select the range of your Spiral shot, and activate it. After a countdown on the HUD, **ANAFI USA** tilts its camera down and starts moving up and rotating. An animation flashes on the screen of your device, and the “Spiral” box progressively fills with green as the Cineshot unfolds.

Epic

The Epic Cineshot offers another great way to dramatize any scene or location. When it is activated, **ANAFI USA** moves away backward in a smooth ascending line, keeping its subject in the center of its frame for 30 or 60 meters. The Epic Cineshot gives best results when **ANAFI USA** starts from a close-up position, relative to its subject.

Before you activate the Epic Cineshot, check the area behind ANAFI USA is clear from obstacles, and safe.

Tap “30m” (small-arrow icon) or “60m” (large-arrow icon) to select the range of your Epic shot, and activate it. After a countdown on the HUD, **ANAFI USA** starts moving backward and upward. An animation flashes on the screen of your device, and the “Epic” box progressively fills with green as the Cineshot unfolds.

- ⚠ Activate and monitor all Cineshots with care: always check your automated shot flight plan is clear from obstacles and safe, always retain visual contact with ANAFI USA, and always be ready to reclaim control of your drone: any action on any stick of Parrot Skycontroller 3 immediately terminates the current Cineshot.**

PILOTING MODES

Tap the "PILOTING MODE" box in the bottom bar of the HUD of **FreeFlight 6** to access the piloting modes options.

Tap a mode to select it. Each mode is associated with a specific behavior, which this section describes.

Manual flight

The Manual flight mode is **ANAFI USA**'s default mode. It enables you to pilot the drone and fully control its camera tilt and zoom.

When you release the commands in Manual flight mode, **ANAFI USA** stays in position, hovering.

Cameraman

The Cameraman mode enables you to keep an object or a subject in the center of your frame, while you pilot **ANAFI USA** around it/him/her.

Frame the object or subject you want to film and fly around.

Tap the "PILOTING MODE" box in the bottom bar of the HUD to access the options. Tap "Cameraman" to select this piloting mode.

Draw a rectangle with your finger on the screen of your device, around the object or subject you want **ANAFI USA** to follow – or double tap this object or subject. When your target is locked, the blue rectangle turns to green and the orange "LAND" box at the center of the top bar of the HUD turns red and displays "STOP". **ANAFI USA**'s frame centers on your target, inside the green box.

Drag the green box to the area of the frame where you want your target to remain at.

Fly **ANAFI USA** around your target. The drone keeps your target in the part of the frame you have selected. Therefore, if you push the right joystick of the **Parrot Skycontroller 3** to the left, **ANAFI USA** circles around your target clockwise. If you push the right joystick of the **Parrot Skycontroller 3** to the right, **ANAFI USA** circles around your target counterclockwise.

When the Cameraman mode is activated, **ANAFI USA** manages the gimbal tilt to keep the target in the frame. Therefore, the left trigger of the **Parrot Skycontroller 3** is deactivated in this mode. However, you can still control the zoom, with the right trigger.

When you release the commands in the Cameraman mode, **ANAFI USA** hovers and rotates to keep following the target.

To end the following of your target, tap the red "STOP" box at the center of the top bar of the HUD.

When no target is selected, or when the following of the target has been ended by the pilot, ANAFI USA's behavior is similar to that of the Manual flight mode.

- ⚠ **Activate and monitor the Cameraman mode with care: always check your flight plan and the trajectory of your subject are clear from obstacles and safe, always retain visual contact with ANAFI USA, and always be ready to stop the following (tap the "STOP" box of your HUD) in case a danger or any sort of unexpected obstacle arises.**

Follow Me

The Follow Me mode was designed to enable ANAFI USA pilots to have their drone follow them in action. It must be purchased from the Google (Android) or Apple (iOS) stores to be activated.

Fly ANAFI USA at least 5 meters (15ft) high and 10 meters (30ft) in front of you, facing you – FreeFlight 6 will inform you with a red alert at the bottom of the HUD if you are too close from ANAFI USA or if it is flying too low.

Frame yourself.

Tap the "PILOTING MODE" box in the bottom bar of the HUD to access the options. Tap "Follow Me" to select this piloting mode.

Both a drone GPS synchronization and a device GPS synchronization are imperative to activate this mode: upon first activation, the following page appears.

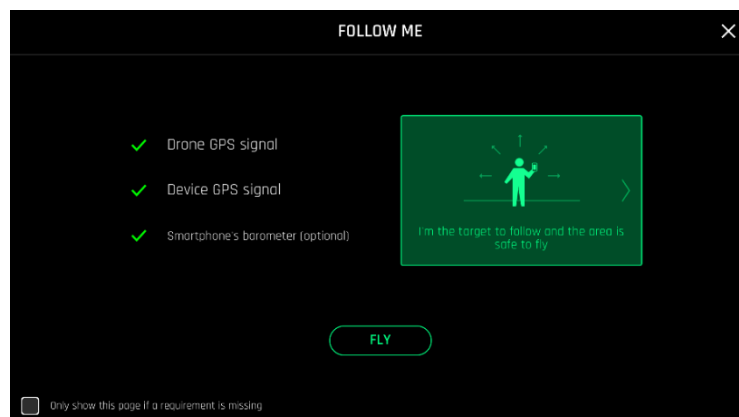

iOS, Follow Me GPS warning

Tick the box on the bottom left on the page if you do not want this warning to appear again when no prerequisite is missing. Tap "FLY" to access the Follow Me mode.

Select one of the three Follow Me options (refer to in-app explanations for details):

Track

Lock

Dynamic (Parrot recommends you only use this option in completely open and unobstructed areas)

Draw a rectangle with your finger on the screen of your device, around yourself. When **ANAFI USA** has a lock on you, the blue rectangle turns to green and the orange "LAND" box at the center of the top bar of the HUD turns red and displays "STOP".

By default, **ANAFI USA** keeps you in the center of the frame, but you can drag the green box to the area of the screen you want to remain at. If you push the right joystick of the **Parrot Skycontroller 3** to the left, **ANAFI USA** circles around you clockwise. If you push the right joystick of the **Parrot Skycontroller 3** to the right, **ANAFI USA** circles around you counterclockwise.

In the Follow Me mode, **ANAFI USA** manages the gimbal tilt to keep you in the center of the frame. Therefore, the left trigger of the **Parrot Skycontroller 3** is deactivated in this mode. However, you can still control the zoom, with the right trigger.

When you release the commands in the Follow Me mode, **ANAFI USA** keeps following you from a constant distance if you are moving. If you stay immobile, **ANAFI USA** stops and stays focused on you.

To have **ANAFI USA** stop tracking you, tap the red "STOP" box at the center of the top bar of the HUD.

When no target is selected, or when the tracking has been ended by the pilot, **ANAFI USA's** behavior is similar to that of the Manual flight mode.

In addition, the Follow Me mode features a series of exclusive Dronies which can be activated as you move, always keeping you in the center of the frame. For each Dronie, two options are available (they are listed between brackets):

- **Orbit (left or right):** **ANAFI USA** circles around you in a full 360°.
- **Parabola (10 or 30 m):** **ANAFI USA** flies in a circular arc over your head, gaining 10 or 30 meters in altitude and turning 180° at its peak.
- **Tornado (10 or 30 m):** **ANAFI USA** performs a double "Orbit" around you, one going up 10 or 30 meters, the other going down 10 or 30 meters, back to its original height.
- **Boomerang (30 or 60 m):** **ANAFI USA** flies away from you for 30 or 60 meters, with an ascending angle following that of the starting gimbal tilt, then comes back to its starting point.

To select a Follow Me Dronie, make sure you are in the Follow Me mode and that **ANAFI USA** is tracking you.

Tap the "Select Dronie" box in the bottom bar of the HUD.

Tap a Dronie to select it. Tap the option you have chosen to activate the Dronie: after 2 seconds, **ANAFI USA** starts moving around you. The corresponding Dronie box fills with green as the Dronie unfolds.

- ⚠ **Activate and monitor the Follow Me mode and each Dronie with care: always check your flight plan is clear from obstacles and safe, always retain visual contact with ANAFI USA, and always be ready to stop the following (tap the "STOP" box of your HUD) in case a danger or any sort of unexpected obstacle arises.**
- ⚠ **To optimize the drone's tracking, always make sure you remain visible by ANAFI USA: do not let an obstacle obstruct the camera's view and do not hide in the shadows, or ANAFI USA could lose track of you.**

Smartdronies

ANAFI USA features four Smartdronies:

- the **Orbit**, **Parabola** and **Boomerang** Dronie can be accessed through this menu - refer to the above section for details about the **Boomerang** Dronie;
- however, the smartest of **ANAFI USA**'s dronies is the **Dolly Zoom**.

We will not spoil it for you: just make sure you have a memorable scenery behind you. Frame yourself (or better yet, your group of friends!) with **ANAFI USA**: keep the drone at least 5 meters away, at man level, between 1 and 2 meters above the ground.

Check that the flight path of your drone is perfectly clear: at least 30 meters behind it, flat and without obstacles.

Tap "Smartdronies" from the "PILOTING MODE" box menu.

As for the Follow Me mode, both a drone GPS synchronization and a device GPS synchronization are imperative to activate this mode: upon first activation, the same warning page appears as for the Follow Me mode. Tick the box on the bottom left on the page if you do not want this warning to appear again when no prerequisite is missing. Tap "FLY" to access the Smartdronies mode.

Tap the Dolly Zoom Dronie to open its three options: try them all and enjoy the magic!

MAP-BASED FLYING MODES

Flight Plan

Flight Plan is a powerful tool, which enables you to fully prepare and configure your flights and filming sessions, from home, on the train, in a plane, or anywhere else you can take your phone with you.

Through an example, this section will teach you the basics of automated flight and shooting management, with ANAFI USA and Flight Plan.

Tap Flight Plan from the "PILOTING MODE" box menu. The map of your surroundings opens full screen. If you are not connected to ANAFI USA, the minimized live view is black, as on the screen captures that follow. Find your next dream flying spot on the map.

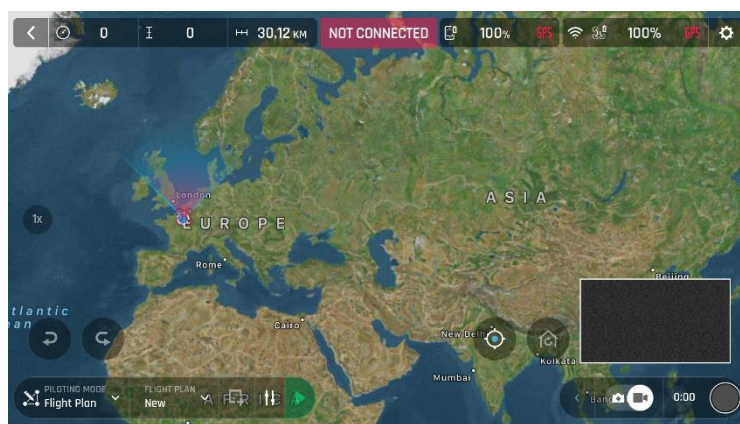

iOS Flight Plan

Consider this pointy bit of land, with a lighthouse in the middle. Say you could fly ANAFI USA and shoot a film there. Let's do it!

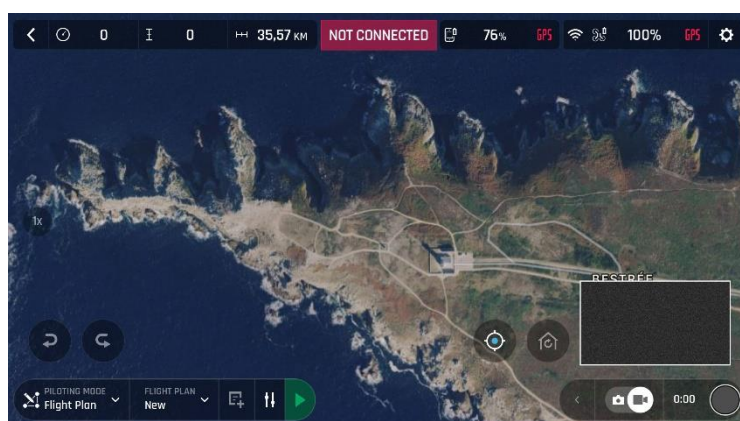

iOS: new Flight Plan

First, select your initial waypoint: ideally, very close to your intended take-off point. Tap the screen to set it. The green circle represents the waypoint, the white figure the altitude of the drone, and the white arrow the direction of ANAFI USA's camera.

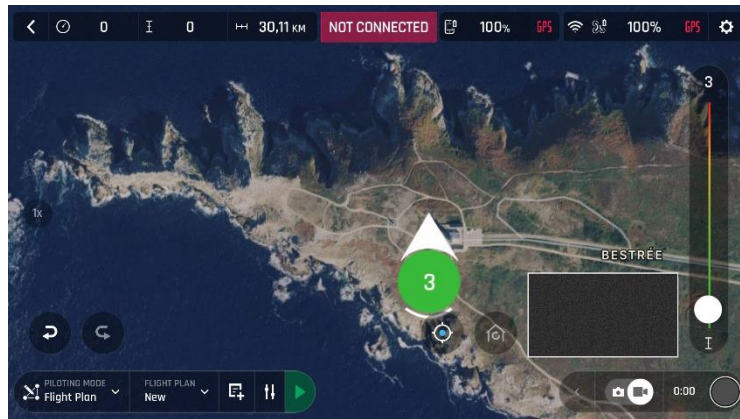

iOS: initial waypoint (WP)

Tap the white arrow and hold it to move it around. In this example, we want ANAFI USA to frame the lighthouse as it starts the flight.

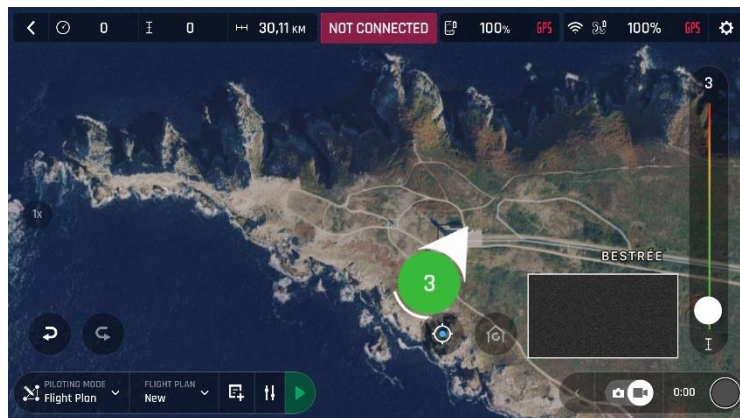

iOS: initial waypoint, with the camera framing the lighthouse

Tap the map to set the second waypoint: the distance between the two waypoints appears on the screen. Use the slider on the right of the screen to set the altitude of the waypoint. In this example, **ANAFI USA** will climb from 3 to 30 meters between the initial waypoint and the second waypoint.

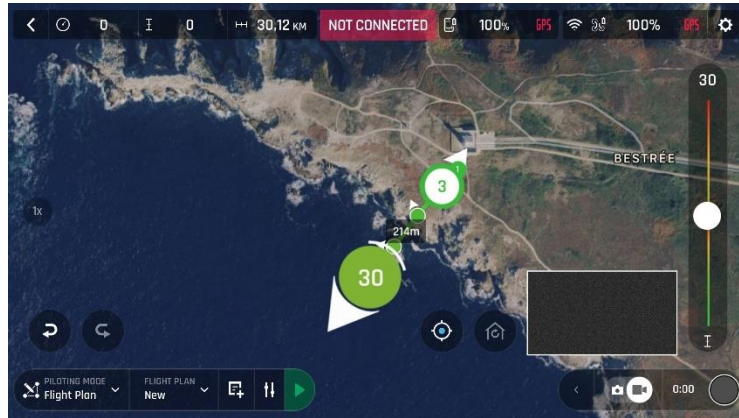

iOS: second waypoint

Add waypoints to tour the area and end your Flight Plan where you intend to land.



iOS: full Flight Plan

The tip of the peninsula is a POI: we want **ANAFI USA** to focus on it while it flies around it. Tap it and hold your finger on the screen to call choices (POI/Close).



iOS: setting a POI

Tap “Point of interest” to add the POI. It appears as a blue square diamond. The figure in the center represents the height of the POI, which you can modify using the slider on the right of the screen. All waypoints turn white as they can now be selected to be linked to the POI.

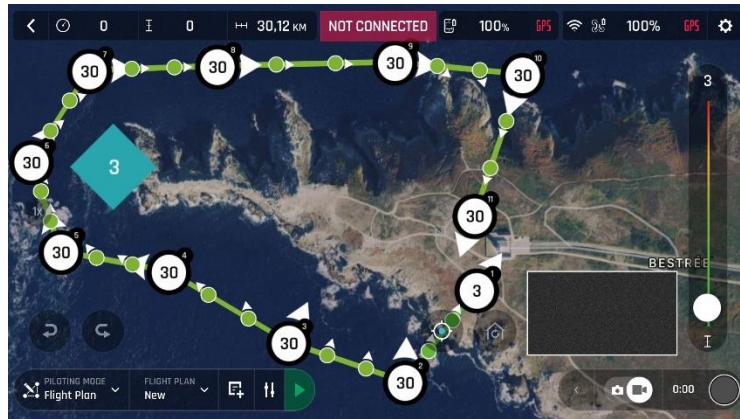

iOS: open waypoints

Tap waypoints to link them to the POI. In this example, we want ANAFI USA to film the tip of the peninsula as it flies around it; we have selected the three waypoints to the left of the peninsula. The arrows of those waypoints have turned toward the POI and are colored in blue – the last one which was selected has a blue border around the white arrow.



iOS: three waypoints linked to the POI

Tap the POI to confirm your choices. Blue waypoints are linked to the POI, which appears as a white square diamond with a blue border. During the entire blue part of the flight, **ANAFI USA**'s camera will stay focused on the tip of the peninsula, enabling you to achieve the smoothest flyby shoot. Green waypoints remain independent from the POI.



iOS: POI Flight Plan

Tap a green waypoint to edit it: use the slider on the right of the screen to modify its height; tap and move its white arrow to set the direction of **ANAFI USA**'s camera. For this example, we had the drone point toward the land at most steps of the Flight Plan, and toward the lighthouse at take-off and landing, with a descent from 30 to 3 meters between the last two waypoints.

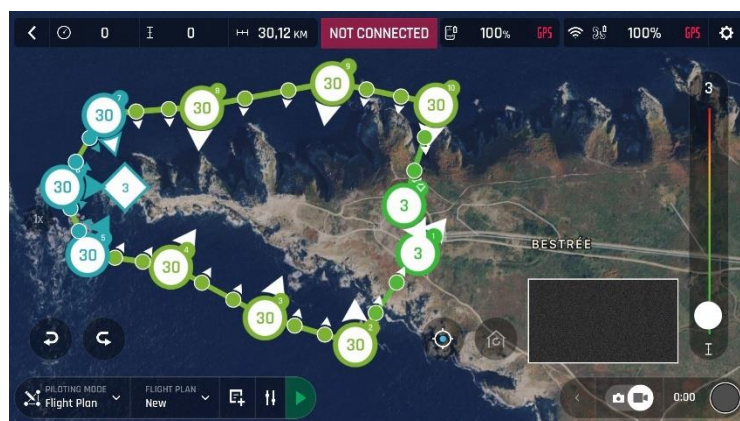

iOS: POI Flight Plan

All you have to do now is to close **FreeFlight 6**, to get to your flying spot, to prepare **ANAFI USA**, your **Parrot Skycontroller 3** and your device for the flight.

Tap the "PILOTING MODE" box on the HUD to call the options. Select "Flight Plan": the last plan you have set up appears.

Tap the green arrow on the right of the left bottom bar of the Flight Plan interface to begin the Flight Plan: ANAFI USA takes off, flies to the first waypoint and starts the Flight Plan. At the end of the Flight Plan, depending on your settings and depending on your version of FreeFlight 6, ANAFI USA lands at, or hovers over, the last waypoint you have set.

That is why, for this section, we have chosen to consider that ANAFI USA's final waypoint is also its landing spot.

- ⚠ **Activate and monitor every Flight Plan with extreme care: always check your drone's route is clear from obstacles and safe, always retain visual contact with ANAFI USA, and always be ready to stop the Flight Plan (tap the "STOP" box of your HUD or reclaim commands of the drone) in case a danger or any sort of unexpected obstacle arises.**

Touch & Fly: Waypoint

Waypoint is the default “Touch & Fly” mode. It enables you to fly **ANAFI USA** to any point on the map. Tap “Touch & Fly” from the “PILOTING MODE” box menu. The map of your surroundings opens full screen. The live image captured by **ANAFI USA** is minimized in the bottom right corner of your screen.

Tap a point on the map to select a destination for ANAFI USA: this point is marked as a white circle with a green border. For each new Waypoint Touch & Fly session, FreeFlight 6 asks you to confirm the first destination of **ANAFI USA** as on the following screen capture. Tap the green “TAP HERE TO START” box, **ANAFI USA** flies toward its designated destination. Use the slider on the right of the screen to control the drone's altitude (the green figure inside the circle) when it reaches its destination.

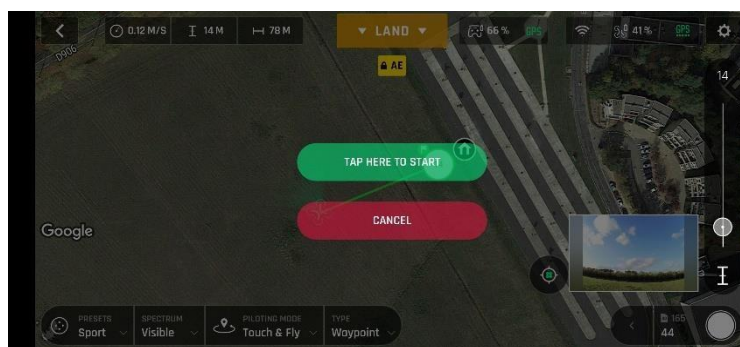

Android Touch & Fly Waypoint: first destination confirmation screen

- ⚠ Activate “Touch & Fly” Waypoint with care: be especially careful with your touches on the screen in this mode, as after the initial confirmation, any tap on the map will immediately send **ANAFI USA** to the corresponding spot.

For this reason, Parrot recommends you set your FreeFlight 6 filming or photography options before activating the “Touch & Fly” Waypoint mode. If, by mistake, you have sent **ANAFI USA** toward a dangerous area, tap the STOP box at the center of the top bar of the HUD, or firmly reclaim commands from the Parrot Skycontroller 3.

Touch & Fly: POI

To access the POI Touch & Fly option, tap the “Type” box from the lower bar of the HUD, and select POI.

In POI mode, tap a point on the map to create a point of interest (POI), marked as a white square diamond with a blue border, labelled with a POI icon. Control the height of the POI (the blue figure inside the square diamond) through the slider on the right: this effectively controls the tilt of the gimbal, while you use the Parrot Skycontroller 3 to fly around your target. **ANAFI USA** remains focused on the POI.



Android Touch & Fly: POI

Tap "STOP" from the red box at the center of the top bar of your screen to halt **ANAFI USA**, or to reset a POI.

From the "Smartdronies" box, next to the "Type" box of the lower bar of the HUD, you can also activate Smartdronies (Orbit, Parabola, Dolly Zoom, Boomerang) of your POI. Refer to the "Smartdronies" section of this guide for additional information on Smartdronies types.

APPENDIX 1: TROUBLESHOOTING GUIDE

This guide addresses all issues ANAFI USA users may have encountered while discovering and using a drone from the ANAFI USA series.

DO NOT CONTACT PARROT SUPPORT before you have applied the procedures and tips relevant to your issue.

TROUBLESHOOTING PROCEDURES

ANAFI USA drone hard reset

Hard resetting ANAFI USA reverts ANAFI USA's most recent firmware to its original state. Parrot recommends the drone hard reset as a first intent procedure for several issues, notably gimbal calibration troubles.

1. Check a compatible microSD card is inserted into ANAFI USA.
2. Power **ANAFI USA** on (short press on the battery's power button).
3. Wait for the gimbal to calibrate (or for the gimbal calibration to fail).
4. Press and hold the battery's power button: after 8 seconds a battery's LED lights up in red.
5. Release the battery's power button: **ANAFI USA** powers off briefly then reboots.
6. Check the contents of **ANAFI USA**'s microSD card: the hard reset procedure has generated a .TXT document named "wifi_security_key" at the root of the microSD card. This document confirms the hard reset procedure is complete and successful.

ANAFI USA's smart battery hard reset

Hard resetting ANAFI USA's battery is useful to correct any battery issue. Parrot recommends a battery hard reset whenever the battery's behavior strays from its expected behavior.

1. Plug your smart battery to a power source.
2. Regardless of the battery's behavior, press and hold its power button for 15 seconds.
3. Release the power button: the battery's LED run successively in green and red, then flash alternatively in green.
4. The battery's hard reset is complete.

Reboot all systems

Rebooting all systems is useful to solve connectivity issues (black screen, white noise, etc.).

1. Power **ANAFI USA** off.
2. Close the **Parrot Skycontroller 3**.
3. Kill **FreeFlight 6** on your device.
4. Reboot your device.
5. Open the **Parrot Skycontroller 3**.
6. Power **ANAFI USA** on.
7. Wait for synchronization between **Parrot Skycontroller 3** and **ANAFI USA** (steady dark blue LED on the controller); check that the left trigger of the **Parrot Skycontroller 3** activates the drone's gimbal to ensure the synch is complete.
8. Plug your device to the **Parrot Skycontroller 3**.

Pairing ANAFI USA to a Parrot Skycontroller 3

This procedure is useful to pair a drone and a controller which have never been paired, and to restore the lost pairing between a drone and a controller.

1. Power **ANAFI USA** on.
2. Open the **Parrot Skycontroller 3** to power it on.
3. Plug the drone and the controller together with an USB-A (controller) to USB-C (drone) cable.
4. The LED of the **Parrot Skycontroller 3** flashes briefly in green: it is acknowledging **ANAFI USA**.
5. Wait for synchronization between **Parrot Skycontroller 3** and **ANAFI USA** (steady dark blue LED on the controller); check that the left trigger of the **Parrot Skycontroller 3** activates the drone's gimbal to ensure the synch is complete.
6. Unplug the controller from the drone.

ISSUES

What do I do if I experience a connectivity issue (black screen, white noise, thermography camera activation failure, frozen or lagging stream)?

1. Check that your device's Wi-Fi is disabled: Parrot even recommends you set your device in Airplane mode when you fly **ANAFI USA**, to minimize the risks of communication disturbance.
2. **Reboot all systems** (refer to the relevant procedure in the earlier section of this guide).

What do I do if my **ANAFI USA**'s gimbal does not calibrate?

Hard reset ANAFI USA (refer to the relevant procedure in the earlier section of this guide).

What do I do if my **ANAFI USA** does not power on?

Make sure your smart battery is "awake": plug it to a power source to take it out of wintering mode, and its LED should start flashing to acknowledge the fact it is charging – Parrot recommends you always fully charge your smart battery before you fly **ANAFI USA**.

What do I do if my battery shows a strange behavior (flashing LED, red LED, etc.)?

Reset the smart battery (refer to the relevant procedure in the earlier section of this document).

What do I do if I cannot read properly the information displayed by **FreeFlight 6**?

1. Access the settings of your device.
2. Find the "Display / Text and display size" (or equivalent) options.
3. Turn down the "text size" of your device, its "display size", or both to let **FreeFlight 6** accommodate all its information on your screen.

What do I do if my **ANAFI USA** is connected to the **Parrot Skycontroller 3**, but won't take off when I hit the take-off button?

1. If you had not done it, plug your device (in airplane mode, or at least Wi-Fi turned off) to your **Parrot Skycontroller 3**.
2. The drone or controller boxes of the homepage of **FreeFlight 6** either signal you that:
 - you must update your Parrot Skycontroller 3, your **ANAFI USA**, or both;
 - or you must calibrate your **ANAFI USA**'s gimbal;
 - or you must carry out a magnetometer (drone) calibration;
 - or you must calibrate your **Parrot Skycontroller 3**.

What do I do if my **ANAFI USA** flips over at take-off?

The propeller blades have been improperly installed. Remove all propeller blades and reinstall them properly and carefully, following the instructions enclosed in all **ANAFI USA** propeller blades packs.

What do I do if my **Parrot Skycontroller 3** does not synch with my **ANAFI USA**?

1. Check no device is connected on **ANAFI USA**'s Wi-Fi network, with **FreeFlight 6** running.
2. Pair your **ANAFI USA** to your **Parrot Skycontroller 3** (refer to the relevant procedure in the earlier section of this document).

What do I do if my Parrot Skycontroller 3 does not synch with my device?

1. Try connecting your **Parrot Skycontroller 3** and your device with a different cable, to eliminate the potential faulty cable issue.
2. When you have eliminated the faulty cable issue, and if you still cannot get the controller and device to synch, close your **Parrot Skycontroller 3** to turn it off.
3. Try connecting your device to your **ANAFI USA's** Wi-Fi network and open **FreeFlight 6**.
4. If your device does not connect to **ANAFI USA**, try uninstalling **FreeFlight 6** and reinstalling it (WARNING: if you use an iOS terminal, remember to save your **FreeFlight 6** media on your device or on a computer, as uninstalling **FreeFlight 6** will delete all your media).
5. When your device and **ANAFI USA** are connected, plug your device to your **Parrot Skycontroller 3**.
6. After less than a minute, the full ecosystem connection (**FreeFlight 6** on the device, **Parrot Skycontroller 3**, **ANAFI USA**) should be restored.

*If the full connection is not restored, contact Parrot Support as your **Parrot Skycontroller 3's** USB - A connector is probably damaged.*

What do I do in the unlikely event my ANAFI USA has sustained a crash?

⚠ FIRSTLY YOU MUST CHANGE ALL YOUR PROPELLER BLADES BEFORE ATTEMPTING ANOTHER FLIGHT; PROPELLER BLADES ARE INSTRUMENTAL FOR FLIGHT INTEGRITY AND DELICATE PIECES OF EQUIPMENT, AND EVEN "MINOR" CRASHES CAN INVISIBLY DAMAGE THEIR STRUCTURE.

1. Set up **ANAFI USA** for a flight.
2. Check the **ANAFI USA** page of FreeFlight 6: any permanently damaged element (gimbal or motor) will appear in red - if an element is damaged, refer to point 8 below.
3. If no element is damaged, carry out the calibration(s) requested by FreeFlight 6 (gimbal, magnetometer, or both).
4. Fly **ANAFI USA** in a mission, take pictures and videos.
5. Check your **ANAFI USA** pictures and videos to see if your drone's horizon is offset.
6. If your horizon is offset, carry out the "Correct horizon" procedure (refer to **ANAFI USA's** User Guide for details) of **FreeFlight 6's** "Camera" Preferences
7. If the "Correct horizon" function cannot make your horizon straight again, it means a part of your gimbal has been deformed and your drone needs service and a new calibration - refer to point 8 below.
8. Note that if the crash has damaged a component of **ANAFI USA** which is essential to a safe flight (such as its vertical camera or its ultra-sonar), your drone will not be able to take off and a FreeFlight 6 alert will tell you to contact your Parrot Support Partner. In this case, be ready to provide the Parrot Support Partner with:
 - a. **the serial number of your ANAFI USA;**
 - b. **a proof of the purchase (invoice) of your ANAFI USA;**
 - c. **the full contents of your microSD card "FDR" folder.**

APPENDIX 2: OPERATIONAL CHECKLIST

This foolproof checklist has been developed with military ANAFI series drone pilots.

If it is useful to them, it is useful to every ANAFI USA pilot.

Update & calibration

| | |
|------------------------------------|---------|
| Device | UPDATED |
| FreeFlight 6 | UPDATED |
| Skycontroller 3 | UPDATED |
| ANAFI USA | UPDATED |
| Magneto calibration | OK |
| Skycontroller 3 calibration | OK |
| Gimbal calibration | OK |

Skycontroller 3 & ANAFI USA OFF

| | |
|--|--|
| Arms | unfolded, locked |
| Arms mechanical lash | NONE |
| Lens cap | OFF |
| Check drone and gimbal | OK |
| Check propellers | intact, free |
| Check Skycontroller 3 | OK, 100 % charged |
| Check terminal to Skycontroller 3 cable | OK |
| If terminal = tablet | Skycontroller 3 tablet holder: OK |
| ANAFI USA battery | OK, 100% charged |
| ANAFI USA battery LED | 4 x OK |
| ANAFI USA battery temp | OK |
| Device | OK, 100% charged |
| MicroSD card | Inserted |
| ANAFI USA battery | 3 hooks engaged in drone, locked |

Skycontroller 3 & ANAFI USA ON

| | |
|---|--|
| Skycontroller 3 (SC3) | open, ON, flashing light to dark blue LED |
| ANAFI USA | ON, gimbal calibration OK |
| SC3 / ANAFI USA Wi-Fi connection | steady dark blue LED on SC3, L trigger moves gimbal: OK |
| Device | ON, Wi-Fi & Bluetooth OFF |
| Device / SC3 link | FreeFlight 6 launched, image feed & telemetry: OK |
| Flight mode selection | MANUAL |
| RTH Height | set (20m to 100m) |
| Max altitude | set |
| Max distance | set |
| Geofence | activated if needed |
| Image settings | OK |
| Check Stick Mode | Inverted / Special mode |
| Map on app | OK |
| Micro SD card | Formatted |
| Battery levels | XXX% (report on flight log if ≠ from 100%) |
| Global reactivity | set |
| Camera tilt speed | set |
| Inclination | set |
| Vertical speed | set |
| Rotation speed | set |

Before take-off

| | |
|-----------------------------|---------------------|
| ANAFI USA GPS signal | Red / Orange /Green |
| Device GPS signal | Red / Green |
| Flight mode | MANUAL |
| Weather | OK |
| TO Zone | Clear |
| Drone status | Check |
| Take-off/Land command | Take-off |

After take-off

| | |
|-----------------------|--|
| Precise Home Set | Depending on conditions / 10 secs or 10 meters |
| Check Stick Mode | Inverted / Special mode |
| Flight mode | MANUAL |
| Check flight commands | OK |
| Check gimbal | OK |
| Video feed | OK |
| Video latency | OK |
| Drone status | Check |

Before landing

| | |
|-----------------------|--------|
| Flight mode | MANUAL |
| Weather | OK |
| Landing Zone | Clear |
| Drone status | Check |
| Take-off/Land command | Land |

After landing

| | |
|-----------------------------------|----------------------------|
| Check engines off | OK |
| Drone status | Check |
| ANAFI USA Battery | OFF |
| Skycontroller 3 | Closed, OFF |
| Check drone / gimbal / propellers | OK |
| Lens cap | ON |
| ANAFI USA Battery | Disengaged, stored away |
| Micro SD card | Stored away |
| ANAFI USA arms | Folded, no mechanical lash |
| ANAFI USA drone | Stored away |
| Device | OFF / Stored away |
| Skycontroller 3 | Stored away |
| Cables | Stored away |

Documents

| | |
|-------------------------|----------------------|
| Flight & batteries info | Report on flight log |
|-------------------------|----------------------|

If you have feedback or comments about the v6.7.0.1 of this user guide, please reach out to:

technical.writer@parrot.com