

FEELWORLD®

TP2 DSLR CAMERA VERSION

TP2A SMARTPHONE+DSLR UNIVERSALVERSION

## PRODUCT INSTRUCTION

Smartphone/Tablet/DSLR Teleprompter

Patent product, Support wide angle lens

Patent No:202120181964.6





# Contents

- ◆ Packing list
- ◆ Structure
- ◆ Installation
- ◆ App Download
- ◆ Remote Controller

## Packing List

### TP2 DSLR Camera Version Packing List

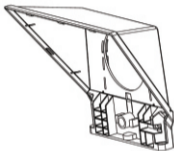

Teleprompter

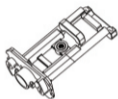

Smartphone/Tablet clamp



Lens adapter  
(49/52/55/58/62/67/72/77mm)



Remote controller



Drawstring bag



Microfiber cloth



User Manual

## Packing List

### TP2A DSLR Camera + Smartphone Version Packing List

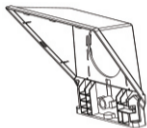

Teleprompter



Smartphone/Tablet clamp



Magnetic smartphone clamp



Lens adapter  
(49/52/55/58/62/67/72/77mm)



Foam ring



Remote controller



Drawstring bag



Microfiber cloth



User Manual

## Structure

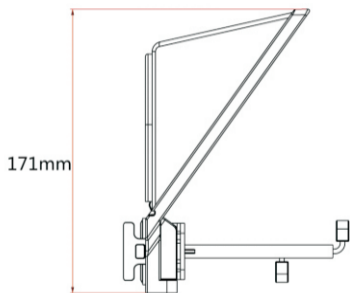
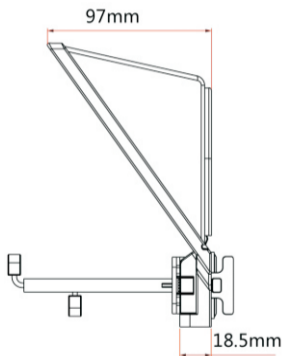

## Structure

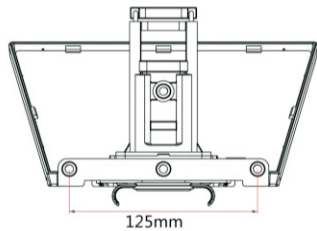
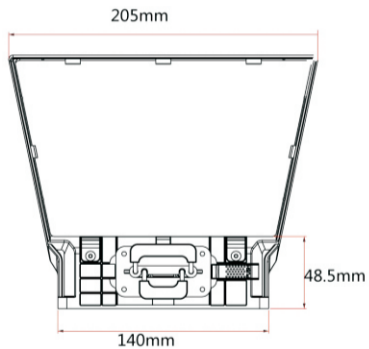

## Installation

### 1. Tablet /Smartphone Prompting, DSLR Camera Recording Supports below 7.9" for smartphone/tablet



Take out the suitable lens adapter to install on your camera



Install the teleprompter on the camera



Install the phone/tablet clamp



Push the "PUSH" to lock the phone/tablet



Put the tablet or phone on the tablet/phone clamp



Install the whole teleprompter on the tripod



Turn on the camera and watch the DSLR display adjust the focus of lens to full screen



## Installation

### 2. Smartphone Prompting, Smartphone Recording



Make sure put it  
The adapter ring



Put the foam ring  
on well



Put the magnetic the  
back of teleprompter



Put it on the middle  
phone clamp on the  
phone



Can be sucked on  
the of the phone



Put a foam ring on can  
be sucked below side  
of the teleprompter



Position of back of  
the teleprompter



Vertical Screen



Horizontal screen



Install the phone/tablet  
clamp (the side which  
suit for phone)On the  
teleprompter



Push the "PUSH" to lock  
the phone/tablet clamp



Put phone on the  
phone clamp



Install the whole  
teleprompter on the  
tripod



Turn on the recording of  
the phone, and make  
sure the full screen

## APP Download

iOS APP Download



iOS user search "FEELWORLD"

Android APP Download



Scan the QR code to download the APP

## Remote Controller

### Remote Button Instruction



**NOTICE:** Due to different brand phone, some smartphone function will be different after connected the remote.

## Remote Controller

### Remote Use Instruction

- 1.Power on: Keep press power button, until the lights on (about 2 seconds).
- 2.Power off: Keep press power button, until the lights off (about 5 seconds).

Notice: if power on without connect anything, it will power off after 5 minutes;  
if connected the phone, it will power off after 30 minutes.

### 3.iOS Connect

Turn on the Bluetooth of the phone first, then turn on APP, and power on the remote controller last. LED lights on, auto into pairing mode, allowing the Bluetooth pair. The APP will show automatically connected to Feelworld-02, and the connection is successful.

What can I do if my iPhone can not connect with remote controller?

- 1, pls go to bluetooth connection of your phone, check if remote controller had been connected by iphone;
- 2,then follow below steps to reconnect: 1) disconnect iphone Bluetooth , and switch off remote controller; 2) turn on iPhone bluetooth, open app, and then switch on remote controller.

## Remote Controller

### 4.Android Connect

After power on, LED lights on, auto into pairing mode. Open the software, tap the app Bluetooth icon to allow the app to turn on Bluetooth, tap the app Bluetooth icon again, find the address and name of the device (Feelworld-X), and tap connect.

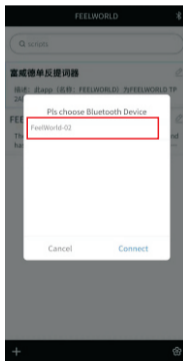

FAQ: The remote controller can not connect the Android phone, how can I do?

1. Please check Location Permission on your phone, the connection need turn on permission.
2. Please check if the remote controller has been connected with your phone.
3. Please check if there is Bluetooth signal from remote controller.(check by other app to detect the Bluetooth )
4. Reboot the remote controller, reopen the app.

FAQ:The remote controller has been connected my Android phone, but it can not control the app.

1. Please close other app at background on your phone.
2. Please turn off Bluetooth on other phones on worksite, to make sure your Android phone is the only device to connect the remote controller.
3. Please make sure that every time to connect with your phone is by app, not by Setting on you phone.



